

Grandstream Networks, Inc.

GRP260x Series - User Guide



Thank you for purchasing Grandstream GRP260X Essential IP Phones.

The GRP Series of Essential IP Phones provides simple, easy-to-use devices with zero touch provisioning for mass deployment and easy management. The four devices in the Essential series are designed to offer simple-to-use, affordable desktop IP Phones with a sleek design and next-generation features. Built for the needs of on-site and remote workers and designed for easy deployment by enterprises, service providers and other high-volume markets, these essential IP phones offer an easy-to-use and easy-to-deploy voice endpoint.

PRODUCT OVERVIEW

Feature Highlights

The following tables contain the major features of the GRP260x:

| | |
|---|---|
|  <p>GRP2601 GRP2601P GRP2601W</p> | <ul style="list-style-type: none"> ● 4 programmable context-sensitive soft keys. ● 10/100M network ports. ● Integrated PoE (for GRP2601P only). ● 5-way conference. ● Electronic Hook Switch (EHS) support for Plantronics & Jabra & Sennheiser. ● Wi-Fi support (GRP2601W only). |
|  <p>GRP2602 GRP2602P GRP2602W GRP2602G</p> | <ul style="list-style-type: none"> ● 2 SIP account keys with dual-color LED ● 4 programmable context-sensitive soft keys. ● 10/100M network ports. (1000M for GRP2602G) ● Integrated PoE (for GRP2602P/GRP2602G only). ● 5-way conference. ● Electronic Hook Switch (EHS) support for Plantronics & Jabra & Sennheiser. ● Wi-Fi support (GRP2602W only). |
|  <p>GRP2603 GRP2603P</p> | <ul style="list-style-type: none"> ● 3 SIP account keys with dual-color LED. ● 4 XML programmable context sensitive soft keys ● 132 x 64 backlit graphical LCD display ● 10/100/1000 Mbps Ethernet ports. ● Integrated PoE (GRP2603P only). ● 5-way conference. ● Electronic Hook Switch (EHS) support for Plantronics & Jabra & Sennheiser. |
|  <p>GRP2604</p> | <ul style="list-style-type: none"> ● 3 SIP account keys with dual-color LED. ● 4 XML programmable context sensitive soft keys ● 132 x 64 backlit graphical LCD display ● 10/100/1000 Mbps Ethernet ports. ● Integrated PoE (GRP2604P only). ● 5-way conference. ● Electronic Hook Switch (EHS) support for Plantronics & Jabra & Sennheiser. |

Technical Specifications

The following table resumes all the technical specifications including the protocols/standards supported, voice codecs, telephony features, languages, and upgrade/provisioning settings for the GRP260x series.

| | |
|-----------------------------|--|
| Protocols/Standards | SIP RFC3261, TCP/IP/UDP, RTP/RTCP, RTCP-XR, HTTP/HTTPS, ARP, ICMP, DNS(A record, SRV, NAPTR), DHCP, PPPoE, SSH, TFTP, NTP, STUN, SIMPLE, LLDP, LDAP, TR-069, SNMP, 802.1x, TLS, SRTP, IPV6 |
| Network Interfaces | Dual switched auto-sensing 10/100 Mbps Ethernet ports, integrated PoE (GRP2601P only) |
| Graphic Display | 132 x 48 (2.21") LCD display |
| Wi-Fi | GRP2601W, Single frequency, 2.4 GHz, 802.11 b/g/n/ax (2.4G only) |
| Feature Keys | 4 XML programmable context sensitive soft keys, 5 (navigation, menu) keys. 8 dedicated function keys for: MESSAGE (with LED indicator), TRANSFER, HEADSET, MUTE, SEND/REDIAL, SPEAKERPHONE, VOL+, VOL |
| Voice Codec | RJ9 headset jack (allowing EHS with Plantronics & Jabra & Sennheiser headsets) |
| Auxiliary Ports | RJ9 headset jack (allowing EHS with Plantronics & Jabra & Sennheiser headsets) |
| Telephony Features | Hold, transfer, forward, 5-way conference, call park, call pickup, downloadable phonebook (XML, LDAP, up to 2000 items), call waiting, call log (up to 800 records), off-hook auto dial, auto answer, click-to-dial, flexible dial plan, hot-desking, personalized music ringtones and music on hold, server redundancy and fail-over |
| Base Stand | Yes, 1 angle positions available |
| Wall Mountable | Yes, (*wall mount sold separately) |
| QoS | Layer 2 QoS (802.1Q, 802.1P) and Layer 3 (ToS, DiffServ, MPLS) QoS |
| Security | User and administrator level passwords, MD5 and MD5-sess based authentication, 256-bit AES encrypted configuration file, SRTP, TLS, 802.1x media access control, secure boot. |
| Multi-language | <p>LCD Language: English 简体中文 (Simplified Chinese) العربية (Arabic) Català (Catalan) Čeština (Czech) Deutsch (German) Ελληνικά (Greek) Español (Spanish) Français (French) עברית (Hebrew) Hrvatski (Croatian) Magyar (Hungarian) Italiano (Italian) 日本語 (Japanese) 한국어 (Korean) Latviešu valoda (Latvian) Nederlands (Dutch) Polski (Polish) Português (Portuguese) Русский (Russian) Svenska (Swedish) Slovenščina (Slovenian) Slovenčina (Slovak) Türkçe (Turkish) Українська (Ukrainian) 正體中文 (Traditional Chinese)</p> <p>WebUI Language: English 简体中文 (Simplified Chinese) العربية (Arabic) Čeština (Czech) Deutsch (German) Español (Spanish) Français (French) עברית (Hebrew) Hrvatski (Croatian) Magyar (Hungarian) Italiano (Italian) 日本語 (Japanese) 한국어 (Korean) Nederlands (Dutch) Polski (Polish) Português (Portuguese) Русский (Russian) Slovenščina (Slovenian) Türkçe (Turkish) 繁體中文 (Traditional Chinese)</p> |
| Upgrade/Provisioning | Firmware upgrade via FTP/TFTP / HTTP / HTTPS, mass provisioning using GDMS/TR-069 or AES encrypted XML configuration file |

| | |
|--|---|
| Power & Green Energy Efficiency | Universal Power Supply Input 100-240VAC 50-60Hz; Output +5VDC, 600mA; PoE: IEEE802.3af Class 1, 3.84W; IEEE802.3az (EEE) (GRP2601P Only) |
| Physical | Dimension: 208mm (L) x 180mm (W) x 63.4mm (H) (with handset) Unit weight:650g; Package weight:810g (860g for GRP2601) |
| Temperature and Humidity | Operation: 0°C to 40°C Storage: -10°C to 60°C Humidity: 10% to 90% Non-condensing |
| Package Content | GRP2601/2601P phone, handset with cord, base stand, universal power supply (GRP2601 only), network cable, Quick Installation Guide |
| Compliance | FCC: Part 15 Class B; FCC Part 68 HAC; CE: EN 55032; EN 55035; EN 61000-3-2; EN 61000-3-3; EN 62368-1; RCM: AS/NZS CISPR32; AS/NZS 62368.1; AS/CA S004; IC: ICES-003; CS-03; |

GRP2601/GRP2601P/GRP2601W Technical Specifications

| | |
|----------------------------|---|
| Protocols/Standards | SIP RFC3261, TCP/IP/UDP, RTP/RTCP, RTCP-XR, HTTP/HTTPS, ARP, ICMP, DNS(A record, SRV, NAPTR), DHCP, PPPoE, SSH, TFTP, NTP, STUN, SIMPLE, LLDP, LDAP, TR-069, SNMP, 802.1x, TLS, SRTP, IPV6 |
| Network Interfaces | Dual switched auto-sensing 10/100 Mbps (1000 Mbps for GRP2602G) Ethernet ports, integrated PoE (GRP2602P/GRP2602G only) |
| Graphic Display | 132 x 48 (2.21") backlit graphical LCD display |
| Wi-Fi | Yes, Dual band support (GRP2602W only) |
| Feature Keys | 2 SIP account keys with dual-color LED, 4 XML programmable context sensitive soft keys, 5 (navigation, menu) keys. 8 dedicated function keys for: MESSAGE (with LED indicator), TRANSFER, HEADSET, MUTE, SEND/REDIAL, SPEAKERPHONE, VOL+, VOL- |
| Voice Codec | Support for G7.29A/B, G.711μ/a-law, G.726, G.722(wide-band), G723, iLBC, OPUS, in-band, and out-of-band DTMF(in audio, RFC2833, SIP INFO), VAD, AEC, CNG, PLC, AGC |
| Auxiliary Ports | RJ9 headset jack (allowing EHS with Plantronics & Jabra & Sennheiser headsets) |
| Telephony Features | Hold, transfer, forward, 5-way conference, call park, call pickup, shared-call-appearance (SCA)/bridged-line-appearance (BLA), downloadable phonebook (XML, LDAP, up to 2000 items), call waiting, call log (up to 800 records), off-hook auto dial, auto answer, click-to-dial, flexible dial plan, hot-desking, personalized music ringtones and music on hold, server redundancy and fail-over |
| HD audio | Yes, HD handset and speakerphone with support for wideband audio |
| Base Stand | Yes, 1 angle positions available |
| Wall Mountable | Yes, (*wall mount sold separately) |
| QoS | Layer 2 QoS (802.1Q, 802.1p) and Layer 3 (ToS, DiffServ, MPLS) QoS |
| Security | User and administrator level passwords, MD5 and MD5-sess based authentication, 256-bit AES encrypted configuration file, SRTP, TLS, 802.1x media access control, secure boot |

| | |
|--|--|
| Multi-language | <p>LCD Language: English 简体中文 (Simplified Chinese) العربية (Arabic) Català (Catalan) Čeština (Czech) Deutsch (German) Ελληνικά (Greek) Español (Spanish) Français (French) עברית (Hebrew) Hrvatski (Croatian) Magyar (Hungarian) Italiano (Italian) 日本語 (Japanese) 한국어 (Korean) Latviešu valoda (Latvian) Nederlands (Dutch) Polski (Polish) Português (Portuguese) Русский (Russian) Svenska (Swedish) Slovenščina (Slovenian) Slovenčina (Slovak) Türkçe (Turkish) Українська (Ukrainian) 正體中文 (Traditional Chinese)</p> <p>WebUI Language: English 简体中文 (Simplified Chinese) العربية (Arabic) Čeština (Czech) Deutsch (German) Español (Spanish) Français (French) עברית (Hebrew) Hrvatski (Croatian) Magyar (Hungarian) Italiano (Italian) 日本語 (Japanese) 한국어 (Korean) Nederlands (Dutch) Polski (Polish) Português (Portuguese) Русский (Russian) Slovenščina (Slovenian) Türkçe (Turkish) 繁體中文 (Traditional Chinese)</p> |
| Upgrade/Provisioning | Firmware upgrade via FTP/TFTP / HTTP / HTTPS, mass provisioning using GDMS/TR-069 or AES encrypted XML configuration file |
| Power & Green Energy Efficiency | Universal Power Supply Input 100-240VAC 50-60Hz; Output +5VDC, 600mA; PoE: IEEE802.3af Class 1, 3.84W; IEEE802.3az (EEE) (GRP2602P Only) |
| Physical | Dimension: 208mm (L) x 180mm (W) x 63.4mm (H) (with handset) Unit weight: 670g; Package weight:830g (880g for GRP2602) |
| Temperature and Humidity | Operation: 0°C to 40°C Storage: -10°C to 60°C Humidity: 10% to 90% Non-condensing |
| Package Content | GRP2602 phone, handset with cord, base stand, universal power supply (GRP2602/GRP2602W only), network cable, Quick Installation Guide |
| Compliance | FCC: Part 15 Class B; FCC Part 68 HAC; CE: EN 55032; EN 55035; EN 61000-3-2; EN 61000-3-3; EN 62368-1; RCM: AS/NZS CISPR32; AS/NZS 62368.1; AS/CA S004; IC: ICES-003; CS-03; |

GRP2602/GRP2602P/GRP2602W Technical Specifications

| | |
|----------------------------|---|
| Protocols/Standards | SIP RFC3261, TCP/IP/UDP, RTP/RTCP, RTCP-XR, HTTP/HTTPS, ARP, ICMP, DNS(A record, SRV, NAPTR), DHCP, PPPoE, SSH, TFTP, NTP, STUN, SIMPLE, LLDP, LDAP, TR-069, SNMP, 802.1x, TLS, SRTP, IPV6 |
| Network Interfaces | Dual switched auto-sensing 10/100/1000 Mbps Ethernet ports, integrated PoE (GRP2603P only) |
| Graphic Display | 132 x 64 backlit graphical LCD display |
| Feature Keys | 3 SIP account keys with dual-color LED, 4 XML programmable context sensitive soft keys, 5 (navigation, menu) keys. 9 dedicated function keys for: MESSAGE(with LED indicator), TRANSFER, HOLD, HEADSET, MUTE, SEND/REDIAL, SPEAKERPHONE, VOL+, VOL- |
| Voice Codec | Support for G7.29A/B, G.711μ/a-law, G.726, G.722(wide-band),G723,iLBC, OPUS, in-band, and out-of-band DTMF(in audio, RFC2833, SIP INFO), VAD, AEC, CNG, PLC, AGC |
| Auxiliary Ports | RJ9 headset jack (allowing EHS with Plantronics & Jabra & Sennheiser headsets) |
| Telephony Features | Hold, transfer, forward, 5-way conference, call park, call pickup, shared-call-appearance(SCA)/bridged-line-appearance(BLA), downloadable phonebook (XML, LDAP, up to 2000 items), call waiting, call log (up to 800 records), off-hook auto dial, auto answer, click-to-dial, flexible dial plan, hot-desking, personalized music ringtones and music on hold, server redundancy and fail-over |
| HD audio | Yes, HD handset and speakerphone with support for wideband audio |
| Base Stand | Yes, 2 angle positions available |

| | |
|--|--|
| Wall Mountable | Yes, (*wall mount sold separately) |
| QoS | Layer 2 QoS (802.1Q, 802.1p) and Layer 3 (ToS, DiffServ, MPLS) QoS |
| Security | User and administrator level passwords, MD5 and MD5-sess based authentication, 256-bit AES encrypted configuration file, SRTP, TLS, 802.1x media access control, secure boot |
| Multi-language | <p>LCD Language: English 简体中文 (Simplified Chinese) العربية (Arabic) Català (Catalan) Čeština (Czech) Deutsch (German) Ελληνικά (Greek) Español (Spanish) Français (French) עברית (Hebrew) Hrvatski (Croatian) Magyar (Hungarian) Italiano (Italian) 日本語 (Japanese) 한국어 (Korean) Latviešu valoda (Latvian) Nederlands (Dutch) Polski (Polish) Português (Portuguese) Русский (Russian) Svenska (Swedish) Slovenščina (Slovenian) Slovenčina (Slovak) Türkçe (Turkish) Українська (Ukrainian) 正體中文 (Traditional Chinese)</p> <p>WebUI Language: English 简体中文 (Simplified Chinese) العربية (Arabic) Čeština (Czech) Deutsch (German) Español (Spanish) Français (French) עברית (Hebrew) Hrvatski (Croatian) Magyar (Hungarian) Italiano (Italian) 日本語 (Japanese) 한국어 (Korean) Nederlands (Dutch) Polski (Polish) Português (Portuguese) Русский (Russian) Slovenščina (Slovenian) Türkçe (Turkish) 繁體中文 (Traditional Chinese)</p> |
| Upgrade/Provisioning | Firmware upgrade via FTP/TFTP / HTTP / HTTPS, mass provisioning using GDMS/TR-069 or AES encrypted XML configuration file |
| Power & Green Energy Efficiency | Universal Power Supply Input 100-240VAC 50-60Hz; Output +5VDC, 600mA;PoE: IEEE802.3af Class 1, 3.84W; IEEE802.3az (EEE) (GRP2603P Only) |
| Physical | Dimension: 214mm (L) x 206mm (W) x 68mm (H) (with handset) Unit weight: 780g; Package weight: 1090g for GRP2603P & 1140g for GRP2603 |
| Temperature and Humidity | Operation: 0°C to 40°C Storage: -10°C to 60°C Humidity: 10% to 90% Non-condensing |
| Package Content | GRP2603 phone, handset with cord, base stand, universal power supply (GRP2603 only), network cable, Quick Installation Guide |
| Compliance | FCC: Part 15 Class B; FCC Part 68 HAC; CE: EN 55032; EN 55035; EN 61000-3-2; EN 61000-3-3; EN 62368-1; RCM: AS/NZS CISPR32; AS/NZS 62368.1; AS/CA S004; IC: ICES-003; CS-03; |

GRP2603/GRP2603P Technical Specifications

| | |
|----------------------------|---|
| Protocols/Standards | SIP RFC3261, TCP/IP/UDP, RTP/RTCP, RTCP-XR, HTTP/HTTPS, ARP, ICMP, DNS(A record, SRV, NAPTR), DHCP, PPPoE, SSH, TFTP, NTP, STUN, SIMPLE, LLDP, LDAP, TR-069, SNMP, 802.1x, TLS, SRTP, IPV6 |
| Network Interfaces | Dual switched auto-sensing 10/100/1000 Mbps Ethernet ports, integrated PoE (GRP2603P only) |
| Graphic Display | 132 x 64 backlit graphical LCD display |
| Feature Keys | 3 SIP account keys with dual-color LED, 4 XML programmable context sensitive soft keys, 5 (navigation, menu) keys. 9 dedicated function keys for: MESSAGE(with LED indicator), TRANSFER, HOLD, HEADSET, MUTE, SEND/REDIAL, SPEAKERPHONE, VOL+, VOL- |
| Voice Codec | Support for G7.29A/B, G.711μ/a-law, G.726, G.722(wide-band),G723,iLBC, OPUS, in-band, and out-of-band DTMF(in audio, RFC2833, SIP INFO), VAD, AEC, CNG, PLC, AGC |
| Auxiliary Ports | RJ9 headset jack (allowing EHS with Plantronics & Jabra & Sennheiser headsets) |

| | |
|--|--|
| Telephony Features | Hold, transfer, forward, 5-way conference, call park, call pickup, shared-call-appearance(SCA)/bridged-line-appearance(BLA), downloadable phonebook (XML, LDAP, up to 2000 items), call waiting, call log (up to 800 records), off-hook auto dial, auto answer, click-to-dial, flexible dial plan, hot-desking, personalized music ringtones and music on hold, server redundancy and fail-over |
| HD audio | Yes, HD handset and speakerphone with support for wideband audio |
| Base Stand | Yes, 2 angle positions available |
| Wall Mountable | Yes, (*wall mount sold separately) |
| QoS | Layer 2 QoS (802.1Q, 802.1p) and Layer 3 (ToS, DiffServ, MPLS) QoS |
| Security | User and administrator level passwords, MD5 and MD5-sess based authentication, 256-bit AES encrypted configuration file, SRTP, TLS, 802.1x media access control, secure boot |
| Multi-language | <p>LCD Language: English 简体中文 (Simplified Chinese) العربية (Arabic) Català (Catalan) Čeština (Czech) Deutsch (German) Ελληνικά (Greek) Español (Spanish) Français (French) עברית (Hebrew) Hrvatski (Croatian) Magyar (Hungarian) Italiano (Italian) 日本語 (Japanese) 한국어 (Korean) Latviešu valoda (Latvian) Nederlands (Dutch) Polski (Polish) Português (Portuguese) Русский (Russian) Svenska (Swedish) Slovenščina (Slovenian) Slovenčina (Slovak) Türkçe (Turkish) Українська (Ukrainian) 正體中文 (Traditional Chinese)</p> <p>WebUI Language: English 简体中文 (Simplified Chinese) العربية (Arabic) Čeština (Czech) Deutsch (German) Español (Spanish) Français (French) עברית (Hebrew) Hrvatski (Croatian) Magyar (Hungarian) Italiano (Italian) 日本語 (Japanese) 한국어 (Korean) Nederlands (Dutch) Polski (Polish) Português (Portuguese) Русский (Russian) Slovenščina (Slovenian) Türkçe (Turkish) 繁體中文 (Traditional Chinese)</p> |
| Upgrade/Provisioning | Firmware upgrade via FTP/TFTP / HTTP / HTTPS, mass provisioning using GDMS/TR-069 or AES encrypted XML configuration file |
| Power & Green Energy Efficiency | Universal Power Supply Input 100-240VAC 50-60Hz; Output +5VDC, 600mA;PoE: IEEE802.3af Class 2, 3.84W-6.49W; IEEE802.3az (EEE) (GRP2604P Only) |
| Physical | Dimension: 208mm (L) x 180mm (W) x 63.4mm (H) (with handset) Unit weight: 670g; Package weight:830g (880g for GRP2602) |
| Temperature and Humidity | Operation: 0°C to 40°C Storage: -10°C to 60°C Humidity: 10% to 90% Non-condensing |
| Package Content | GRP2604 phone, handset with cord, base stand, universal power supply (GRP2604 only), network cable, Quick Installation Guide |
| Compliance | FCC: Part 15 Class B; FCC Part 68 HAC; CE: EN 55032; EN 55035; EN 61000-3-2; EN 61000-3-3; EN 62368-1; RCM: AS/NZS CISPR32; AS/NZS 62368.1; AS/CA S004; IC: ICES-003; CS-03; |

GRP2604/GRP2604P Technical Specifications

GETTING STARTED

This chapter provides basic installation instructions including the list of the packaging contents and information for obtaining the best performance with the GRP260x phone.

Equipment Packaging

| GRP260X |
|---|
| <ul style="list-style-type: none">● 1 x GRP260X Main Case.● 1 x Handset.● 1 x Phone Stand.● 1 x Ethernet Cable.● 1 x Power Adapter (Except for GRP260xP).● 1 x Phone cord.● 1 x Quick Installation Guide. |



1x Phone Main Case



1x Handset

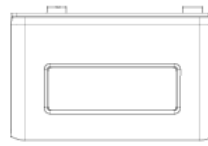

1x Phone Stand



1x Ethernet Cable



1x 5V Power adapter
(With GRP260x Only)



1x Phone Cord

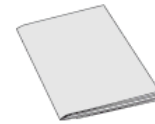

1x Quick Installation Guide

GRP260x Package Content

Note

Check the package before installation. If you find anything missing, contact your system administrator.

Connecting and Setting Up the GRP260x

The GRP260x phones can be installed on the desktop using the phone stand or attached on the wall using the slots for wall mounting.

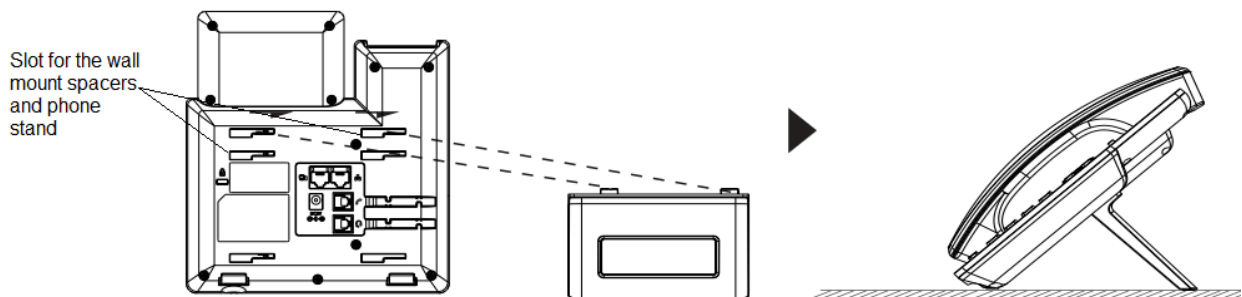

phone Stand and Mounting Slots on the GRP260x

Using the Phone Stand

To install the phone on the table with the phone stand, attach the phone stand to the bottom of the phone through the phone stand slot. (Upper half, bottom part).

Using the Slots for Wall Mounting

1. Attach the wall mount spacers to the slot for wall mount spacers on the back of the phone.
2. Attach the phone to the wall via the wall mount hole.
3. Pull out the tab from the handset cradle (See figure below).
4. Rotate the tab and plug it back into the slot with the extension up to hold the handset while the phone is mounted on the wall (see figure below).

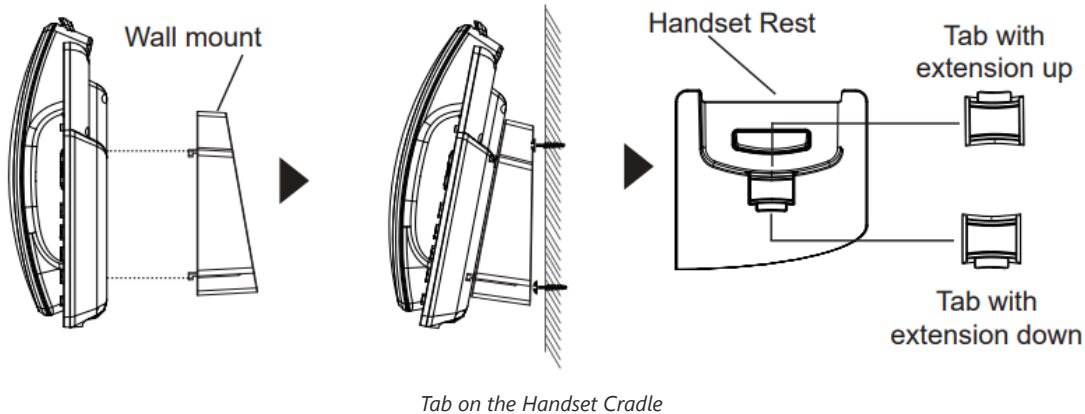

Connecting the GRP260x

To set up the GRP2600, follow the steps below:

1. Connect the handset and main phone case with the phone cord.
2. Connect the LAN port of the phone to the RJ-45 socket of a hub/switch or a router (LAN side of the router) using the Ethernet cable.
3. Connect the PSU output plug to the power jack on the phone; plug the power adapter into an electrical outlet. If a PoE switch is used in step 2 (GRP2601P/GRP2602P/GRP2603P/GRP2604P only), this step could be skipped.
4. The LCD will display the Grandstream logo. Before continuing, please wait for the date/time display to show up.
5. Using the phone embedded web server or keypad configuration menu, you can further configure the phone using either a static IP or DHCP.

Connecting to Wi-Fi Network (GRP2601W and GRP2602W only)

- On the LCD menu, navigate to “Settings → Wi-Fi settings” and enable Wi-Fi.
- Select “Wi-Fi Network” and GRP2601W/GRP2602W will automatically start scanning within the range.
- A list of Wi-Fi networks will be displayed. Select the desired network, and if required, enter the correct password to connect.
- Users can add and connect to a hidden network by accessing “Wi-Fi” Network” and then press on Add softkey . Then enter the Network’s information.

Notes:

- When the GRP2601W/GRP2602W is not connected to any network (including Ethernet and Wi-Fi), a prompt interface will pop up to notify users about it. Users can quickly enter the “Wi-Fi Network” page by pressing on the Wi-Fi softkey.
- For easy deployment, The GRP2601W/GRP2602W is preconfigured out of the box to connect to a default SSID named **wp_master** with a password (WPA/WPA2 PSK) equal to **wp!987@dmn**, users can adapt these settings from the web UI as well to make it easier for deployment on customer site.
- Admin authentication is required for LCD Menu Wi-Fi connections on GRP2601W/GRP2602W.
- Users can configure the PEAP 802.1x Settings from the LCD Menu.

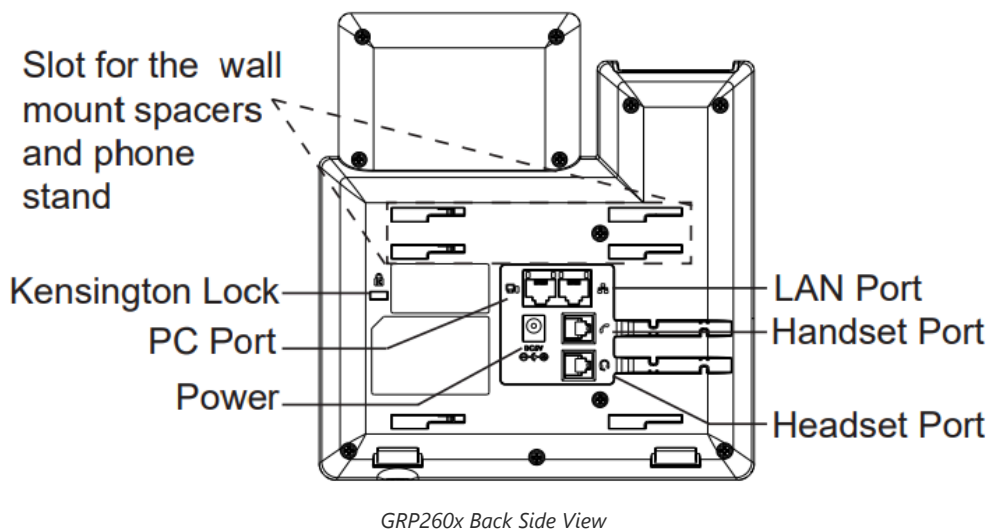

GETTING TO KNOW GRP260X

Idle Screen

GRP260x screen displays differently depending on whether the phone is idle or in use (active). The following figures show the idle screen of GRP260x.

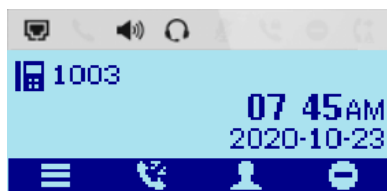





































GRP260x Idle Screen











































The following table describes the items displayed on the GRP260x idle screen:











































| | |
|--------------------------------|--|
| Date and Time | Displays the current date and time. It can be synchronized with Internet time servers. |
| Network icon | Shows the status of network. It will indicate whether the network is down or starting. |
| Status icon | Shows the status of the phone for registration status, call features etc., using icons as shown in the next table. |
| Line status indicator | Displays the name of the account that is in use. |
| Softkeys in idle screen | <p>The softkeys are context sensitive and will change depending on the status of the phone. Default functions assigned to softkeys are:</p> <ul style="list-style-type: none"> ● Menu: Brings up the phone's main menu. ● History: Shows up the phone's call history. ● Contacts: Access local phonebook and groups. ● DND: Enable/Disable DND. <p>Note: The Idle Screen Softkey can be customized under web UI > Programmable Keys > Idle Screen Softkeys > Custom Softkey Layout</p> |
| Softkeys in call screen | <p>The softkeys are context sensitive and will change depending on the call status of the phone. Here are the main softkeys in call screen.</p> <ul style="list-style-type: none"> ● Dial: Dials the call out after off hook and entering the number. ● Answer Call softkey: Answers the incoming call when the phone is ringing. |

























- **Reject Call softkey:** Rejects the incoming call when the phone is ringing.
- **End Call softkey:** Ends the active call.
- **Transfer softkey:** Transfer softkey will show up after pressing TRAN button and entering transfer target number. Press Transfer softkey to do blind transfer.
- **Switch softkey:** In attended transfer mode, after establishing the second call, press on Switch softkey to switch between the two calls.

LCD Display Definitions







| | | | |
|---|---|---|--|
|  | Registered Account |  | Warning |
|  | Registered SCA Account |  | Info |
|  | Unregistered account / account is not available |  | Detail |
|  | Calling / Dialing / Accept |  | The first page |
|  | Incoming Call |  | The second page |
|  | Dial |  | Line Switch Indicator |
|  | Call failed / Missed Call |  | Line Switch Indicator |
|  | Held |  | Right arrow |
|  | Talking |  | Switch_Off |
|  | Edit before dialing |  | Switch_On |
|  | Dial DTMF |  | Mixed Input Method (Default) |
|  | New Call |  | Capital Letter Input Method |
|  | Redial |  | Lowercase Input Method |
|  | Call Return |  | Digital Input Method |
|  | Hang up |  | Settings / Configuration |
|  | Call Waiting |  | Call Center Account available |
|  | Speed Dial/Speed Dial via Active Account |  | Speed Dial/Speed Dial via Active Account |
|  | Transfer |  | Multicast Listen |

| | | | |
|---|---------------------------|---|-------------------------|
|  | Call Forward All |  | Close Call Forward All |
|  | Call History |  | BS Contacts |
|  | Blocked Calls |  | Blocked Calls |
|  | Contact |  | Call Park |
|  | New Contact / Invite |  | Call Pick |
|  | Delete Contact / Remove |  | Delete Contact / Remove |
|  | Group |  | Ringtone Off |
|  | New Group |  | Logout |
|  | Group Members |  | Recording Pause |
|  | Block list |  | Conference Hold |
|  | Remove from Block list |  | Conference Talking |
|  | Clear all Block list |  | Hoteling |
|  | Conference |  | Remote Search |
|  | Incoming Cloud Conference |  | Sort |
|  | Outgoing Cloud Conference |  | Noise Shield |
|  | Missed Cloud Conference |  | Noise Shield Off |
|  | GDS Door |  | More |
|  | GDS Door Open |  | Lock Screen |
|  | Hold |  | Unlock Screen |
|  | UnHold |  | Voicemail Unread |
|  | Recording On |  | Play |

| | | | |
|---|--------------------|---|------------------------|
|  | Recording Off |  | Stop |
|  | Power Off |  | Play Status |
|  | DND |  | Stop Status |
|  | Menu |  | Mark as Unread |
|  | Back |  | Mark as Read |
|  | Download |  | Mark All as Read |
|  | Mark All as Read |  | Bridge |
|  | Downloading |  | Share |
|  | Upgrade System |  | Call Pull |
|  | Edit |  | Password / Lock Status |
|  | Delete |  | Add |
|  | Delete All |  | Wi-Fi |
|  | Refresh |  | Wi-Fi 5G Excellent |
|  | More (page select) |  | Wi-Fi 5G Good |
|  | LDAP Search |  | Wi-Fi 5G Fair |
|  | Search |  | Wi-Fi 5G Poor |
|  | OK / Save |  | Wi-Fi 2.4G Excellent |
|  | Cancel |  | Wi-Fi 2.4G Good |
|  | Backspace |  | Wi-Fi 2.4G Fair |
|  | Switch / Convert |  | Wi-Fi 2.4G Poor |
|  | Text Message |  | Wi-Fi Excellent |

| | | | |
|---|-----------------------|---|----------------------------|
|  | New Text Message |  | Wi-Fi Good |
|  | Speaker |  | Wi-Fi Fair |
|  | Login |  | Wi-Fi Poor |
|  | Ringtone |  | Wi-Fi Disconnect |
|  | Ringtone Off |  | Connect |
|  | Headset |  | Disconnect / Forget |
|  | Voicemail |  | UnRegistered SCA Account |
|  | Intercom |  | Mark All as Unread |
|  | Single Box |  | Noise Filtering |
|  | Checkbox not selected |  | Noise Filtering Off |
|  | Checkbox selected |  | Noise Filtering Status |
|  | Speaker Off |  | Energy Saving Mode enabled |

GRP260X LCD Icons

| Top Banner Icon | Description |
|---|-------------------------------|
|  | Ethernet Port Connected |
|  | Off-Hook Dialing/Ongoing Call |
|  | Speaker Dialing/Ongoing Call |
|  | Headset Port Connected |
|  | Ongoing Call Mute |
|  | Ongoing SRTP Call |

| | |
|---|-----------------------------|
|  | DND Enabled |
|  | Call Forward Always Enabled |

GRP260X LCD Top Banner Icons

Using the Keypad

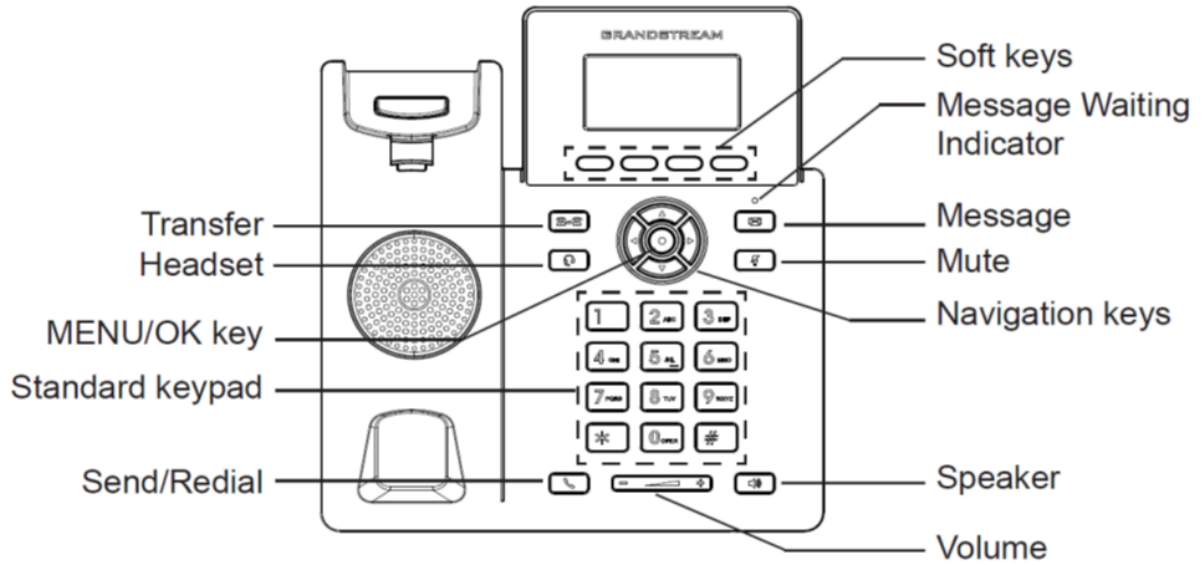

GRP2601 Keyboard

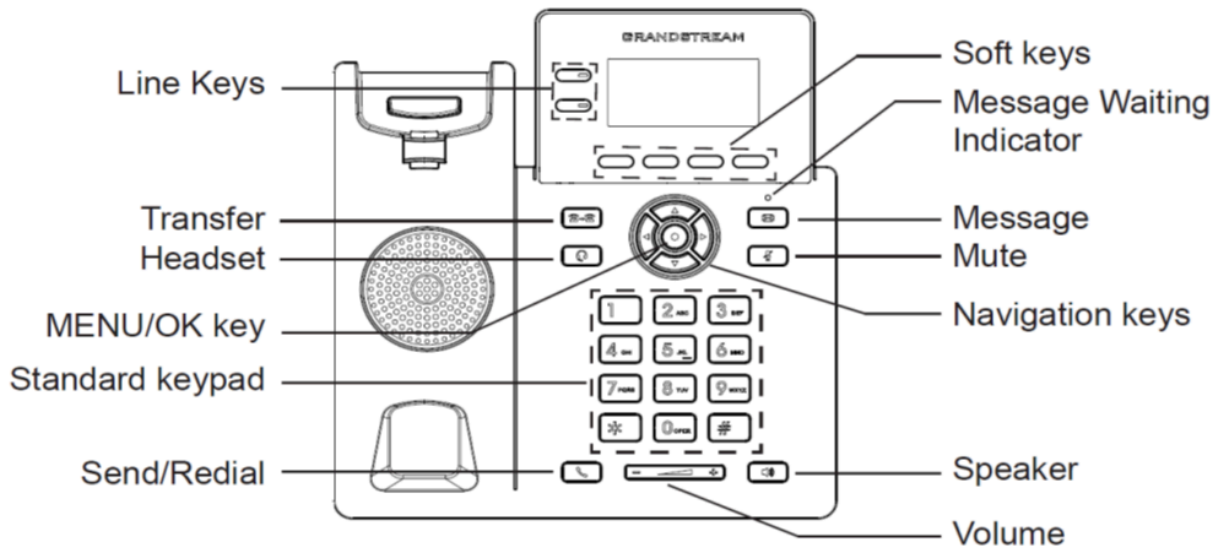

GRP2602 Keyboard

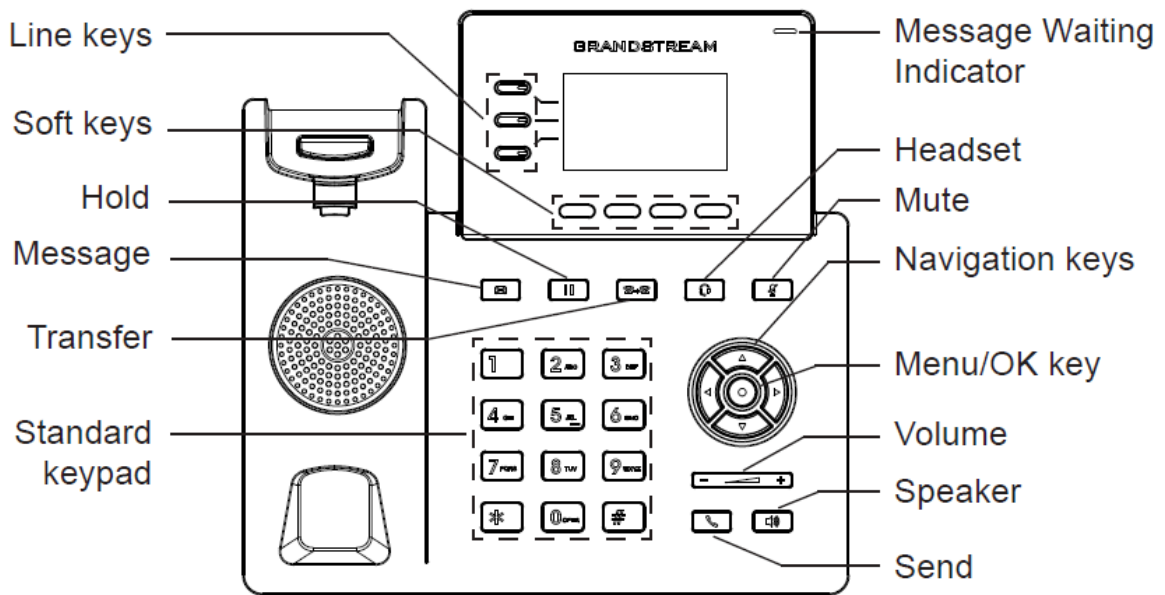



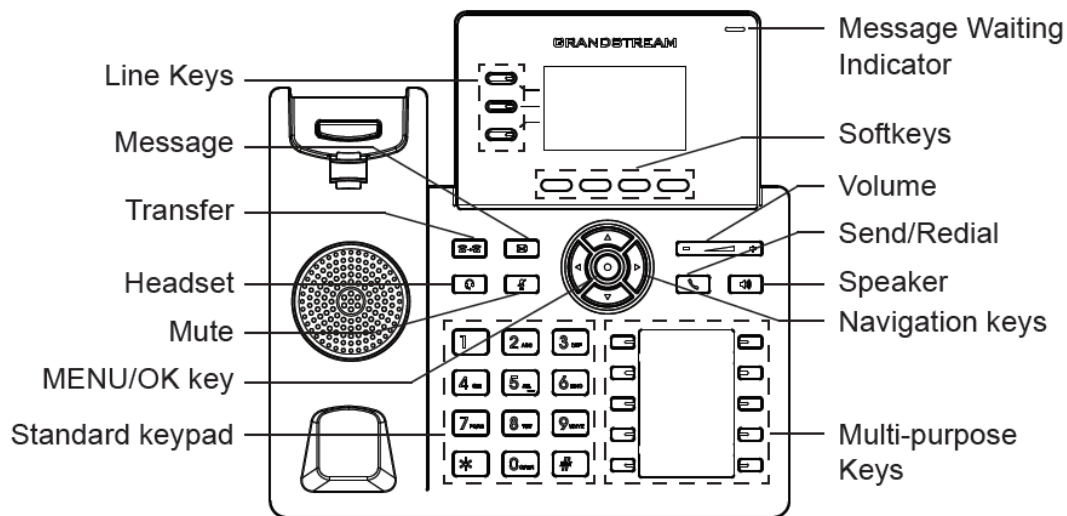

GRP2603 Keyboard



GRP2604 Keyboard

| | |
|--|---|
| | Hold: Press to put call on hold or resume the call. |
| | Mute: <ul style="list-style-type: none"> • During a call, Press Mute button to mute or unmute the call. • When the phone is on idle, Press to Enable/Disable DND |
| | Headset: Press to switch between headset and handset mode in an active call. |
| | Message: Press to view voicemail messages. |
| | Transfer: Press to transfer an active call to another number. |
| | Speaker: Press to switch between speaker and handset mode in an active call. |

| | |
|---|--|
|  | Send/Redial |
|  | Volume: Adjust volume. |
|  | Navigation keys: <ul style="list-style-type: none"> • In idle screen, press up key to display the IP. • When entered the menu, Press the UP/DOWN keys to scroll through menu options. • Use RIGHT/LEFT keys to switch between Tabs or to toggle between enabling and disabling some options. for example: switch between “All” and “Missed” Calls Tabs in call history |
|  | MENU button: <ul style="list-style-type: none"> • In idle screen, press to enter the main menu. • Confirm the current selection or the inputted info. |

GRP260x Keypad Buttons

Configuration via Keypad

To configure the LCD menu using the phone’s keypad, follow the instructions below:

- **Enter MENU options.** When the phone is in idle, press the round MENU button or Menu Softkey to enter the configuration menu.
- **Navigate in the menu options.** Press the arrow keys UP/DOWN keys to navigate in the menu options.
- **Enter/Confirm selection.** Press the round MENU to enter the selected option.
- **Exit.** Press Return Softkey to exit to the previous menu.
- **Return to Home page.**

The MENU options are listed in the following table.

| | |
|-----------------|--|
| Status | <p>Displays account status, network status, software version number and Hardware:</p> <ul style="list-style-type: none"> • Network status: Press to enter the sub menu for IP setting information (DHCP/Static IP/PPPoE), IPv4 address, IPv6 address, MAC address, Subnet Mask, Gateway, DNS and NTP servers. • Account status: Shows Account registration status. • System Status: Press to enter the sub menu for Hardware Information, Software version and IP Geographic Information. |
| Settings | <p>Settings sub menu contains the following options:</p> <ul style="list-style-type: none"> - Account Settings: Enable/Disable SIP account, Configures Account Name, SIP server’s address, SIP User ID, SIP Auth ID, SIP Password, Outbound Proxy, and Voice Mail Access Number. - Call Settings: Enable/Disable DND, Enable Disable Auto Answer for SIP account, Enable/Disable Call Forward (Forward All/Busy/No Answer). - Basic Settings: <ul style="list-style-type: none"> • Sounds: Configures account ringtone and adjusts volume settings by pressing left/right arrow key. • Appearance: Configures the idle and active LCD brightness. • Date and Time: Adjusts Time and Date displaying format. • Time Zone: Choose your Time Zone from the list by scrolling with UP/DOWN keys. • Language: Selects the language to be displayed on the phone’s LCD. Users could select Automatic for local language based on IP location if available. By default, it is Auto. • Keypad Lock: Enables/Disables Keypad lock. Users can choose the Keypad Lock type (All Keys/Functional keys) and set up the lock password. If users enabled Keypad lock without configuring a password; They can unlock the phone by pressing on the unlock softkey. • Headset Type: Choose the headset type of the headset connect to the phone. Users could choose Normal, Plantronics EHS, Jabra EHS, VBeT EHS, Sennheiser EHS. |

| | |
|--------------------------|--|
| | <ul style="list-style-type: none"> ● Softkey bar style: Chooses the corresponding style to show icons , you can choose from four different styles. ● Input Method: Chooses to set the input method to be one of the following options: 123, abc, ABC, Ab2, and Q9 for both the contact input method and LDAP input method, you can define the input language too. ● Key Customization: In this option you can set the hotkey settings to be configured for short press setting, long press setting, or reset the hotkey settings, you can also customize the VPKs by choosing the mode of each VPK to be set to Intercom, conference , call park , speed dial, Transfer... <p>- Advanced Settings:</p> <ul style="list-style-type: none"> ● Upgrade: Check for upgrade by contacting the firmware upgrade server. ● Sys Log: Configures Syslog level, Transport protocol and Syslog Server’s address. ● Security: Enables disables Web and SSH access. ● Alternative Firmware: Press Switch/Convert softkey to switch between the dual firmware versions loaded to the phone. The phone will reboot with the chosen version. ● Language Download: Gives you the option to download the chosen language files or restore them from previous firmware versions, you can also set the update to be either manual or automatic , it manual by default. <p>- Ethernet Settings:</p> <ul style="list-style-type: none"> ● Internet Protocol: Selects Prefer IPv4 / Prefer IPv6 / IPv4 only or IPv6 only. The default setting is “IPv4 only”. ● IPv4 Settings: Selects IP mode (DHCP/Static IP/PPPoE); Configures PPPoE account ID and password; Configures static IP address, Netmask, Gateway, Preferred DNS server ● IPv6 Settings: Selects IP mode (DHCP/Static IP); Configures static IP address, IPv6 Prefix (64 bits), IPv6 Preferred DNS server. ● VLAN Settings: Enables CDP/LLDP, Configures LLDP TX interval, Enables Manual VLAN Configuration, Configures Layer 2 QoS 802.1q (VLAN ID/Priority). ● Reset Network settings: Resets the network configuration <p>- Wi-Fi Settings (GRP2602W only):</p> <ul style="list-style-type: none"> ● Wi-Fi: Enables/disables Wi-Fi. ● Wi-Fi Band: Choose Wi-Fi band (2G , 5G or 2G&5G). ● Wi-Fi Network: Scans and displays available Wi-Fi networks. |
| Messages | <ul style="list-style-type: none"> ● Instant Messages: Displays received instant messages ● Voicemail: Displays voicemail message information in the following format: Normal/Urgent |
| Call History | Displays Local Call Logs: “All” Calls / “Missed” Calls/ “Dialed” Calls/ “Answered” Calls. |
| Contacts | <p>Contacts sub menu includes the following options:</p> <ul style="list-style-type: none"> ● Local Phonebook ● Local Group ● LDAP <p>User could configure phonebooks/groups options here, download phonebook XML to the phone and search and dial from the local phonebook and search and dial from LDAP phonebook.</p> |
| Factory Functions | <p>Factory Functions sub menu includes the following options:</p> <ul style="list-style-type: none"> ● Audio Loopback: Speak to the phone using speaker/handset/headset. If you can hear your voice, your audio is working fine. Press Return Softkey to exit audio loopback mode. ● Keypad/Led Diagnosis: All LEDs will light up Press all the available keys on the phone. The LCD will display the name for the keys to be pressed to finish the keyboard diagnostic mode. Press Hook button to exit. ● Certification Verification: Verify the certificate loaded on the phone. |
| UCM Detect | Configures the IP address and port of the UCM on which the IP phone can be registered. |
| Factory reset | Performs a Factory reset on the phone. |

| | |
|---------------|--------------------|
| Reboot | Reboots the phone. |
|---------------|--------------------|

Configuration Menu

The following picture shows the keypad MENU configuration flow:

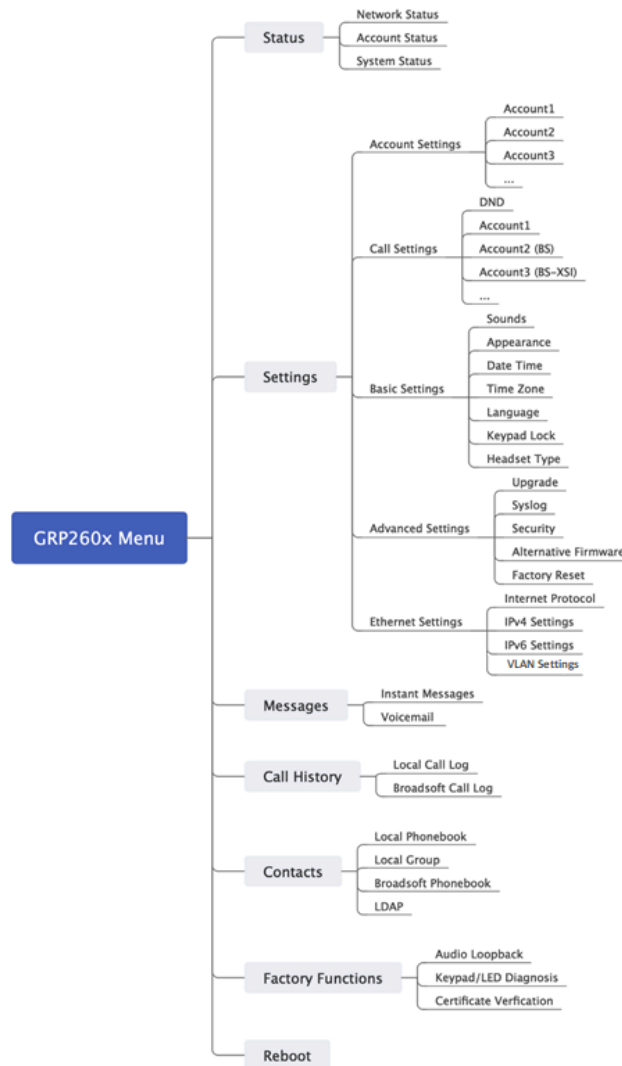

Keypad Menu Configuration Flow

Note

Users can also leverage the **numeric keys** and assign them different functions by pressing the key for **3 seconds** and selecting the **Mode** and **Value**. The **supported modes** are : Speed Dial, Speed Dial via Active Account, Dial DTMF, Voicemail, Call Return, LDAP Search, Call History, INFO, Messages, DND, Redial, Open Door, Provision, HTTP Command.

Characters Input

The GRP260x keypad can be used by tapping on an input field. GRP260x keypad has 4 modes "123", "ABC", "abc" and "Ab2". The default mode is "Ab2". Note: If the input field is accepting only digits, only "123" mode will be available.

- o "123" **Mode:** This mode allows to enter digits and:

The following table describes the allowed characters for each key.

| Key | Description | Key | Description | Key | Description |
|-----|-------------|-----|-------------|-----|-------------|
| 1 | 1 | 2 | 2 | 3 | 3 |

| | | | | | |
|---|---|---|---|---|---|
| 4 | 4 | 5 | 5 | 6 | 6 |
| 7 | 7 | 8 | 8 | 9 | 9 |
| * | . | 0 | 0 | # | : |

Characters Input ABC Mode

- o **"ABC" Mode:** This mode allows to enter capital letters, digits, and symbolic characters.

The following table describes the allowed characters for each key.

| Key | Description | Key | Description | Key | Description |
|-----|---|-----|-------------|-----|-------------|
| 1 | 1.:@+,'"-? !()/_;%=< >\$[]{}~^ ` & | 2 | A B C 2 | 3 | D E F 3 |
| 4 | G H I 4 | 5 | J K L 5 | 6 | M N O 6 |
| 7 | P Q R S 7 | 8 | T U V 8 | 9 | W X Y Z 9 |
| * | * | 0 | 0 | # | # |

Characters Input: ABC Mode

- o **"abc" Mode:** This mode allows to enter small letters, digits, and symbolic characters.

The following table describes the allowed characters for each key.

| Key | Description | Key | Description | Key | Description |
|-----|---|-----|-------------|-----|-------------|
| 1 | 1.:@+,'"-? !()/_;%=< >\$[]{}~^ ` & | 2 | a b c 2 | 3 | e d f 3 |
| 4 | g h i 4 | 5 | j k l 5 | 6 | m n o 6 |
| 7 | p q r s 7 | 8 | t u v 8 | 9 | w x y z 9 |
| * | * | 0 | 0 | # | # |

Characters Input: abc Mode

- o **"Ab2" Mode:** This mode allows to enter capital letters, small letters, digits, and symbolic characters.

The following table describes the allowed characters for each key.

| Key | Description | Key | Description | Key | Description |
|-----|-------------|-----|-------------|-----|-------------|
|-----|-------------|-----|-------------|-----|-------------|

| | | | | | |
|---|--|---|---------------|---|----------------------|
| 1 | 1.:@+,'"-?! ()/_;%=<>\$ []{}~^ `& | 2 | A B C a b c 2 | 3 | D E F e d f 3 |
| 4 | G H I g h i 4 | 5 | J K L j k l 5 | 6 | M N O m n o 6 |
| 7 | P Q R S p q r s 7 | 8 | T U V t u v 8 | 9 | W X Y Z w x y z 9 |
| * | * | 0 | 0 | # | # |

Ab2 Mode

TELEPHONY FEATURES

Make Phone Calls

Handset, Speaker, and Headset Mode

The GRP260X allows users to switch between handset, speaker, or headset when making calls. Press the Hook Switch to switch to the handset; press the Headset button  to switch to headset mode, or press the Speaker button

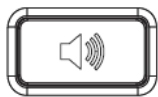

to switch to speaker.

Multiple SIP Accounts and Lines

The GRP2601 supports 2 SIP accounts and 2 lines; GRP2602 supports up to 4 SIP accounts with 2 line keys; GRP2603/GRP2604 supports up to 6 SIP accounts with 3 line keys. Each account is capable of independent SIP server, user, and NAT settings. In off-hook state, select an idle line and the dial tone will be heard. To make a call, select the line you wish to use. The corresponding LINE LED will light up in green. The user can switch lines before dialing any number by pressing the LINE buttons.

Since the GRP260x can have more SIP accounts than the supported lines, the phone is supporting two line key modes; "Line mode" and "Account mode". The main difference between the two is that during calls each line key displays the status of a call line in "Line Mode"; while in "Account mode", available accounts will be displayed in each line key, which is handy in case multiple accounts are using the same line, there will be also the Header and name/number displayed. The figures below show the examples and differences in call screens between the two modes:

Line mode: Each line key is displaying the status of a call line



Account mode: An available account is displayed in each Line key. Users can view the current line and the number of all lines in the upper right corner of the call interface.



Key mode configured as account mode

The key mode setting can be configured from the phone's **Web GUI → Phone Settings → Call Settings**.

SIP URI Calls

SIP URIs typically look like this: `sip:username@domain.com`. When you enter a SIP URI into the GRP260x, it will use the SIP protocol to connect to the specified SIP server or destination, allowing you to establish voice or video calls over the internet.

Example: You have an IP phone in your office, and you want to call a colleague, John Doe, who is also using an IP phone, but he's located in a different office within your organization. John's SIP URI is `sip: johndoe@companyvoip.com`, on the GRP260x, instead of dialing a traditional phone number or an extension, you enter John's SIP URI into the dialing interface, which looks like `sip: johndoe@companyvoip.com`.

Completing Calls

There are several ways to complete a call.

- **On-hook** dialing. Enter the number when the phone is on-hook and then send it out.
 1. When the phone is idle, enter the number to be dialed out;
 2. Take the handset off-hook, or Press the Speaker button, or Press the Headset button with the headset plugged in.
 3. The call will be dialed out.
- **Off-hook and dial.** Off-hook the phone, enter the number, and send it out.
 1. Take handset off-hook; or
 - Press the Speaker button; or
 - Press the Headset button with the headset plugged in; or
 - Press an available LINE key to activate the speaker. (The user can return to the idle screen after pressing again the activated Line key).
 2. You shall hear dial tone after off-hook;
 3. Enter the number;
 4. Press SEND or # keys to dial out.
- **Predictive dialing.** When dialing numbers, based on the entered digit, the phone will predict and list the candidates of the target number.

If the target number is already saved in the phonebook or call history, when entering the first several digits, the phone will display a list of matching numbers. If the target number appears on the list, the user could select the number using the Up/Down key and dial out. GRP260x has a predefined call feature code (the first digit is *). When the user enters * as the first digit of the target number, the phone will list all the available feature codes.

- o **Redial.** Redial the last dialed number.

1. Take handset off-hook; or
 - o Press the Speaker button; or
 - o Press the Headset button with the headset plugged in; or
 - o Press an available LINE key to activate the speaker; or
 - o When the phone is in an idle state;
2. Press SEND key, and the last number called will be redialed.

- o **Via Call History.** Dial the number logged in the phone's call history.

1. Press the MENU button to bring up the main menu then enter Call History; or
2. Press the "History" soft key when the phone is in an idle state;
3. Select the entry you would like to call using the navigation arrow keys;
4. Press SEND button to dial out.

- o **Via Phonebook.** Dial the number from the phonebook.

1. Press the MENU button to bring up the main menu then enter Contacts; or
2. Press the "Contacts" soft key when the phone is in an idle state;
3. Enter Local / BS Phonebook using the navigation arrow keys;
4. Select the contact you would like to call

Note

Pressing the OK button to enter the contact details page , users can edit the phone number and choose which account to dial that number by clicking "Edit before dialing" soft key.

5. Press SEND button to dial the selected contact.

Notes:

- o After entering the number, the phone waits for the No Key Entry Timeout (Default timeout is 4 seconds, configurable via Web GUI) before dialing out. Press SEND or # key to override the No Key Entry Timeout;
- o If digits have been entered after taking the handset off-hook, the SEND key will work as SEND instead of showing the history of Dialed extensions;
- o (#) or (*) can be chosen as send keys from WEB GUI → Accounts → Account X → Call Settings → Key as Send.
- o During an active call, users can see the call info on LCD:
 - The call lasting time
 - Contact information if the number is already saved in the phonebook.
- o An alert tone is generated when the device is initiating a multicast paging and when receiving a multicast paging
- o When a call is missed, a notification will appear on the LCD screen. Users can make outgoing calls without closing the notification.

Making Calls using IP Addresses

Direct IP Call allows two phones to talk to each other in an ad-hoc fashion without a SIP proxy. VoIP calls can be made between two phones if:

- o Both phones have public IP addresses; or
- o Both phones are on the same LAN/VPN using private or public IP addresses; or
- o Both phones can be connected through a router using public or private IP addresses (with necessary port forwarding or DMZ).

To make a direct IP call, please follow the steps below:

1. Press Hook Switch/Speaker or Headset button to bring out the dialing screen.
2. Input the 12-digit target IP address (Please see the example below).
3. Press the **"Dial"** softkey to dial.

Note

When use direct IP call, "Use Random Port" option should be set to "No".

For example:

If the target IP address is 192.168.1.60 and the port is 5062 (i.e., 192.168.1.60:5062), input the following: 192*168*1*60#5062. The * key represents the dot (.), and the # key represents the colon (:).

When only dialing the IP address (example: 192*168*1*60) the call will automatically go through the default port 5060.

Answering Phone Calls

Receiving Calls

- o **Single incoming call.**

The phone rings with the selected ring tone. The corresponding LINE key LED will flash in red for GRP2602(P/G/W)/GRP2603(P)/GRP2604(P) models, the screen will indicate an incoming call as well. Answer call by taking handset off hook, or using Speaker/Headset, or pressing Answer softkey .

Note

If "Enable Incoming Call Indicator" option is enabled, the upper right corner LED indicator will light up for the GRP2603(P)/GRP2604(P), while the message waiting indicator LED will light up for GRP2602(P/G/W)/GRP2601(P/W), signaling that there is an incoming call.

- o **Multiple incoming calls**

When another call comes in while having an active call, the phone will produce a Call Waiting tone (stutter tone). The other LINE key will flash in red (GRP2602/GRP2603/2604). Answer the incoming call by pressing on the Answer softkey or the flashing LINE key in the case of GRP2602/GRP2603/GRP2604. The current active call will be put on hold automatically. Users can switch between the calls using the UP/DOWN keys.

Do Not Disturb

Do Not Disturb can be enabled/disabled from the phone's LCD by following the steps below:

1. Press the Menu button and navigate to **"Settings → Call Settings → Do Not Disturb"**.
2. Use RIGHT/LEFT keys to disable/enable DND;
3. Press the **"Save"** softkey to save the change

Users could also enable/disable DND quickly by pressing the Mute button

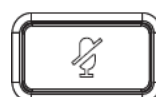

or DND softkey



DND Icon will be displayed on the top right of the status bar indicating that DND is enabled. Incoming calls will not be accepted, or the call will directly go into voicemail.

Notes:

- The mute button function can be set also to idle Mute instead of DND or be disabled under the web GUI option **Phone Settings → Call Settings → Mute Key Function While Idle**.
- During an active call, press the MUTE button to mute/unmute the microphone. The LCD will show the Mute icon on the top of the screen when the call is muted.

Add Contact to Block list

If the contact number belongs to the Block list group, the call from that number will always be blocked.

Users can add a contact to the block list by accessing the local phonebook and selecting the contact in question and then pressing on the block list softkey . A confirmation message "Add this contact to Block list?" will be displayed on the screen, the contact will be added to the block list by pressing on the "Save" softkey.

To unblock a contact, users need to select the contact in question from the phonebook and then press on unblock softkey







During a Phone Call

Call Waiting/Call Hold

Users can place a call on hold by pressing the HOLD softkey  during an ongoing call. The active LINE key will blink in green (GRP2602/GRP2603/GRP2604). The call can be resumed by pressing on the Hold softkey again.

When there is a new call, the call screen will display the new incoming call information, and the Call waiting tone (stutter tone) will be audible during the active call, Use the UP/DOWN keys to switch between the two calls screens.

Users can choose whether to answer the new call using the Answer softkey , Reject the call using the Reject softkey , forward the call using the Transfer/Forward softkey  or mute /silence the call using the silence softkey .

When silence softkey is pressed, the call waiting tone will be muted.

Notes:

- If "On Hold Reminder Tone" is Enabled under web GUI "Account X → Advanced settings" then a reminder tone will be played to notify the user that he has a call on hold.
- If the "Enable call Waiting" Option is set to NO on WEB GUI under Account X → Call Settings the second incoming call will be rejected.

Mute

During an active call, press the MUTE button



to mute/unmute the microphone. The LCD will show the Mute

icon on the top of the screen when the call is muted.

Call Transfer

GRP2601/GRP2602/GRP2603/GRP2604 supports Blind Transfer and Attended Transfer:

- **Blind Transfer.**

1. During an active call, press the TRANSFER button

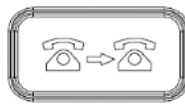

, or the icon ■■■ to display more softkeys then

press the transfer softkey

2. Dial Transfer destination number.

3. Press Transfer softkey

o **Attended Transfer.**

1. During an active call, press the TRANSFER button

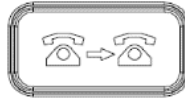

, or the icon ■■■ to display more softkeys then

press the transfer softkey

2. Dial Transfer destination number and press on dial softkey.

3. The first call will be put on hold and a new call will be initiated with the transfer destination.

4. When the second call is answered, Users could press on the Switch softkey to switch to the initial call (The second call will be put on hold) or press on transfer softkey

Notes:

- o To transfer calls across SIP domains, SIP service providers must support transfer across SIP domains.
- o When the " Hold Call before Completing Transfer" Option is set to "No" on the WEB GUI, the phone will neither hold the current call in the transfer window nor hold the call with the transfer target before referring the call in the attended transfer.
- o The Attended Transfer can be finished by on-hooking the phone.

Call Forwarding

When there is an incoming call, users could choose to not take the call and forward it to another number instead by pressing on the Forward /Transfer softkey and then dial the forward target number and press on again, the call will be then immediately forwarded to that number.

Note

Call forward icon is displayed when enabled via feature code with "Feature key sync" is enabled.

Call Park

Call Park is a feature that allows users to put an ongoing call on hold and retrieve it from any another extension. The GRP260x series supports Call Park via VPKs/MPKs as well as Enhanced Call Park using Softkeys.

Call Park using Virtual Multi-Purpose Keys/Multi-Purpose Keys

1. To add a Parking Lot, login to the UCM, go to **Call Features** → **Parking Lot** and click on the button

For this example, we're using the default Parking Lot of the UCM which is "700"

| Parking Lot > Edit Parking Lot: 700 | | | |
|-------------------------------------|--------------------------------------|--------------------------------|---|
| * Parking Lot Extension | <input type="text" value="700"/> | * Parking Lot Name | <input type="text" value="DefaultLot"/> |
| * Parking Slots | <input type="text" value="701-720"/> | Use Parking Slot as Extension | <input type="checkbox"/> |
| * Parking Timeout (s) | <input type="text" value="300"/> | Music on Hold Playlists | <input type="text" value="Default"/> |
| Forward to Destination on Timeout | <input type="checkbox"/> | Fallover Destination | <input type="text"/> |
| Ring-All Callback on Timeout | <input type="checkbox"/> | Parking Lot Timeout Alert-Info | <input type="text" value="None"/> |

- To configure the call park VPK/MPK, go to the corresponding **Programmable Keys** page and choose "CallPark" in **Mode** and enter the Parking Lot under **Value**.

| Order | Mode | Account | Value | Label |
|-------|----------|-----------|-------|-------|
| 1 | Line | Account 1 | 4006 | |
| 2 | CallPark | Account 1 | * 700 | |

Call Park VPK/MPK

- During an ongoing call, press the configured VPK/MPK to park the call.

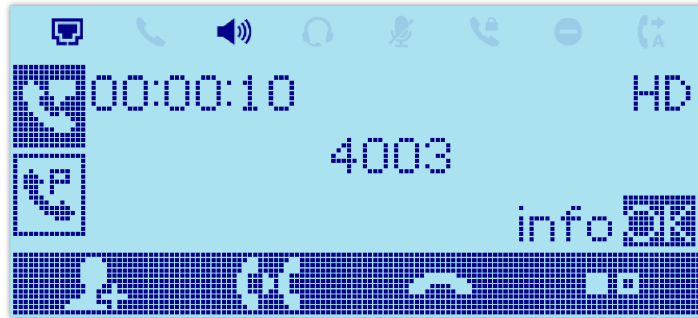

Parking Ongoing Call



Call Parked Successfully

- Once the call is successfully parked, users can either retrieve the call by dialing the correct Parking Slot or by configuring a VPK/MPK to monitor specific parking slots. This can be done by accessing the corresponding **Programmable Keys** page and choosing "Monitored Call Park" in **Mode** and entering the Parking Slot number under **Value**.

| Order | Mode | Account | Value | Label |
|-------|---------------------|-----------|-------|-------|
| 1 | Line | Account 1 | 4001 | |
| 2 | Monitored Call P... | Account 1 | * 701 | |
| 3 | Monitored Call P... | Account 1 | * 702 | |
| 4 | Monitored Call P... | Account 1 | * 703 | |

Monitored Call Parks VPK/MPK

- After the call is parked, the Monitored Call Park VPK/MPK LED indicator turns solid red and the remote extension appears on the LCD screen (for VPK only). Users can press the configured key to pick up the parked call.



Available Parked Call

Enhanced Call Park

To activate the Enhanced Call Park Softkey, users need to access the phone's Web UI and go to **Phone Settings** → **Call Settings**

| Call Park | |
|---|-------------------------------------|
| Enable Call Park Softkey ? | <input checked="" type="checkbox"/> |
| Call Park Softkey Feature Code ? | <input type="text" value="*68"/> |
| Call Park Retrieve Softkey Feature Code ? | <input type="text" value="*88"/> |
| Group Call Park Softkey Feature Code ? | <input type="text" value="*58"/> |

Enhanced Call Park Feature

- Enable Call Park Softkey : used to enable/disable the call park related softkeys.
- Call Park Softkey Feature Code : this feature access code is used to park an ongoing call to an extension or a parking lot.
- Call Park Retrieve Softkey Feature Code : this code allows the user to retrieve a parked call from an account or a parking lot.
- Group Call Park Softkey Feature Code : configures the feature access code to park an ongoing call to the group current user is in.

For this example, we configured all the GRP260x phones with the Feature Codes shown in the screenshot above.

1. During an ongoing call, click on the Call Park softkey.

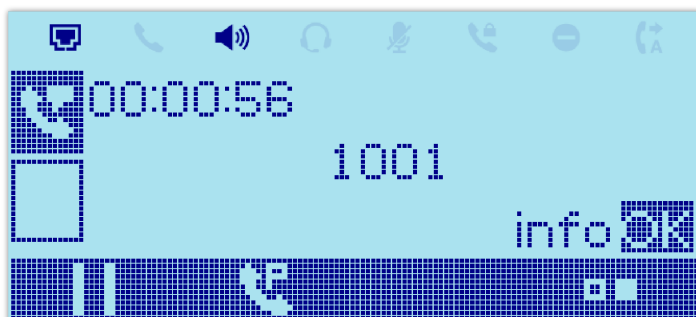

Call Park Softkey During Ongoing Call

2. A new prompt screen will appear to enter an extension to which the call is going to be parked. In this example, we will park the call directly to extension **1003**.

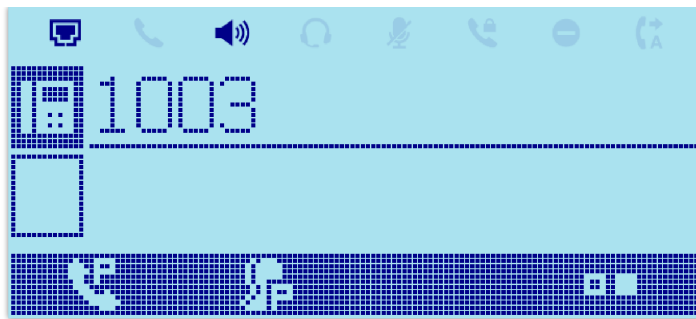

Call Park Screen

3. Press the Call Park softkey again and the below message should appear to confirm the transaction.



Call Parked Successfully

4. On the remote extension, a window will show up to notify the user of the parked call (only for phones that support the Enhanced Call Park feature). The user can access the list of parked calls by pressing the softkey.



Parked Call Notification

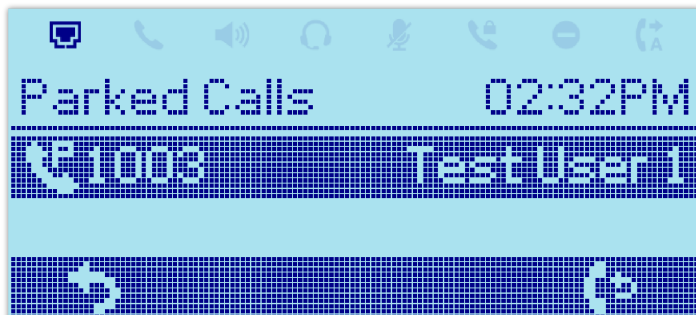

Parked Calls List

5. To retrieve the parked call, the user needs to dial the Retrieve Feature Code followed by their extension. In this scenario the Feature Code is ***88** and the extension number is **1003**.

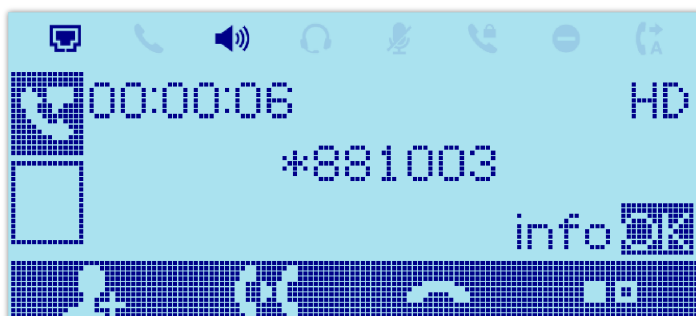

Parked Call Retrieved

Establish Conferencing calls

The GRP260x can host up to 5 conference calls.

Initiate a conference call.

1. Establish the first call.
2. While 1 call is active, press on conference Invite softkey  and dial the second conference number.
3. The conference will be established as soon as the dialed number answers the call.

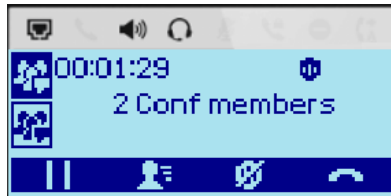



3-way conference call screen example

- **View Conference members.**

Users can view conference members by pressing on the conference info softkey , Information related to conference members will then be displayed.

- **Kick Conference members.**

During the conference, press on conference info softkey  to view conference members. Then use UP/DOWN softkey to select a member and press on kick softkey  to kick the selected number from the conference.

- **End Conference.**

Users could press the End Call soft key  or simply hang up the call to terminate the conference call.

Notes:

- Viewing and kicking conference members is possible only if the phone is the conference host.
- The party that starts the conference call must remain in the conference for its entire duration, you can put the party on mute, but it must remain in the conversation.

Multi-Purpose Keys (GRP2604 Only)

Users can configure Multi-Purpose keys (MPKs) from the phone's **WEB GUI -> Programmable Keys -> Multi-Purpose Keys**. The GRP2604 supports up to 10 MPKs. (Check the figure below)

| Order | Mode | Account | Value | Label |
|-------|-----------------------|-----------|--------|-----------|
| 1 | Speed Dial | Account 1 | * 1000 | John |
| 2 | Busy Lamp Field (BLF) | Account 1 | * 2000 | Jack |
| 3 | Voicemail | Account 1 | * 5555 | VoiceMail |
| 4 | None | Account 1 | | |
| 5 | None | Account 1 | | |
| 6 | None | Account 1 | | |
| 7 | None | Account 1 | | |
| 8 | None | Account 1 | | |
| 9 | None | Account 1 | | |

Preview
After saving, you can print the card style in the preview

1 John 6
2 Jack 7
3 VoiceMail 8
4 9
5 10

Print

MPK page

In this section, The MPKs are listed by order (From 1 to 10). Users can configure an MPK by choosing the **Mode** they need to set (Speed dial, Busy Lamp Field...) and then set the **Value** for the MPK and its **Label** (Description of the button). When done, scroll down and press on **Save** to save the configuration.

The Preview section will show the label of each configured MPK in order:

| Order | Mode | Account | Value | Label |
|-------|--------------------------|-----------|--------|-----------|
| 1 | Speed Dial | Account 1 | * 1000 | John |
| 2 | Busy Lamp Field (BLF) | Account 1 | * 2000 | Jack |
| 3 | Voicemail | Account 1 | * 5555 | VoiceMail |
| 4 | Speed Dial via Active... | | * 1010 | Carl |
| 5 | Transfer | Account 5 | * 1001 | Steve |
| 6 | Busy Lamp Field (BLF) | Account 1 | * 1002 | David |
| 7 | Speed Dial | Account 1 | * 1002 | Michael |
| 8 | Menu | | | Menu |
| 9 | Information | | | Infos |
| 10 | Forward | Account 1 | * 1002 | David |

Preview
After saving, you can print the card style in the preview

1 John 6
2 Jack 7
3 VoiceMail 8
4 Carl 9
5 Steve 10
6 David
7 Michael
8 Menu
9 Infos
10 David

Print

MPK Preview

Note:

Multicast paging can be configured on the MPKs for GRP2604P phones.

Users can print the card containing the configured MPK information by pressing on **Print** and then configure the printing options and preferences such as the Print Destination, print all pages or specific ones, Layout, Paper size, Margins, Scale, whether to display headers and footers and background colors ...

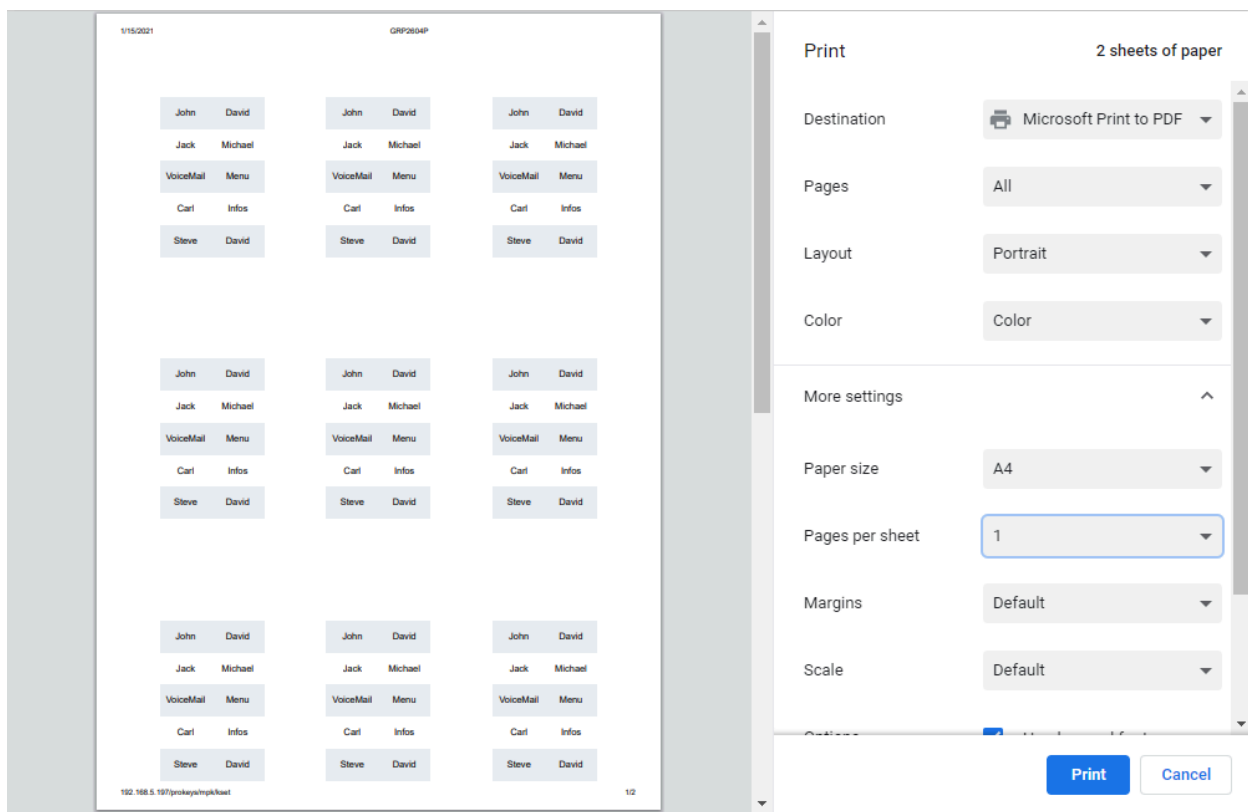

MPK Card printing options

The MPK card can be printed over the dedicated space on the **BLF label** (Which can be found in the GRP2604 package content) and then follow the steps below to install it on the phone:

1. Place the paper label in the groove of the phone.
2. Bend the plastic film so that the protruding points on the left and right sides snap into the grooves to complete the installation.
3. If you want to take it out, use a nail or thin card to move the slit on one side of the film to bend it and then take it out.

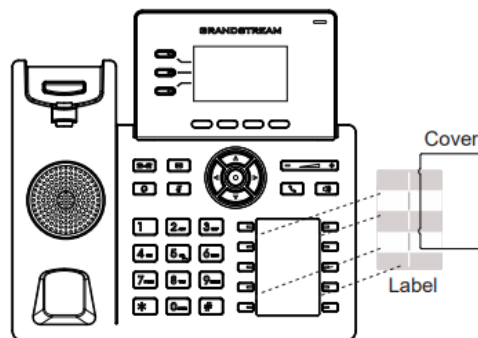

Install the BLF paper

Virtual Multi-Purpose Keys

Users can configure Virtual Multi-Purpose keys (VPKs) from the phone's **WEB GUI -> Programmable Keys -> Virtual Multi-Purpose Keys**. The GRP260X supports up to 12 VPKs. (Check the figure below)

| Order | Mode | Account | Value | Label |
|-------|-----------------------|-----------|-----------------|--------|
| 1 | Default | Account 1 | 899 | Harold |
| 2 | Busy Lamp Field (...) | Account 1 | *2002 | Stev |
| 3 | Multicast Paging | Account 1 | *237.11.10.11:6 | Sup |
| 4 | None | | | |
| 5 | None | | | |
| 6 | None | | | |

VPK Page

In this section, The VPKs are listed by order (From 1 to 12). Users can configure a VPK by choosing the **Mode** they need to set (Speed dial, Busy Lamp Field...) and then set the **Value** for the VPK and its **Label** (Description of the button). When done, scroll down and press on **Save** to save the configuration.

The Preview section will show the label of each configured VPK in order:

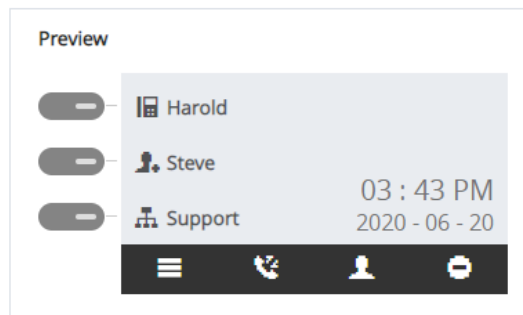

VPK Preview

Virtual Extension Keys

Grandstream's GRP260x series introduces an innovative "Virtual Extension" feature, enabling users to establish additional virtual extension associated with their physical IP phones. These extensions function similarly to separate accounts within a single device, enhancing communication by allowing the management of multiple accounts concurrently. Notably, these Virtual extension can be conveniently controlled via the dedicated "GS EXT" app on the phone or through a web interface, offering enhanced flexibility. This feature combines cost efficiency, easy central management, and smooth integration with different functions, all improving communication and meeting the changing needs of modern workplaces.

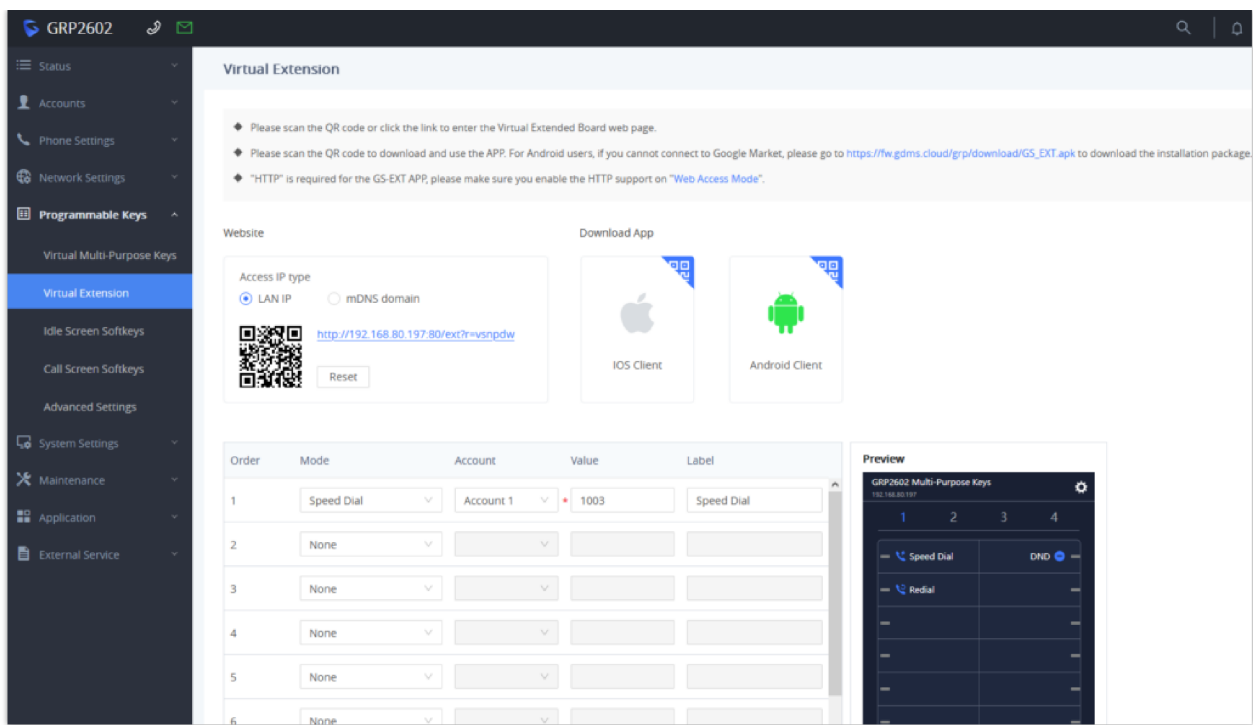

Virtual extensions Tab

Note

For more information on configuring Virtual extensions, please refer to the following guide: [GRP260x Virtual Extension User Guide](#)

Voicemail

The Message waiting indicator situated above the Message button will light up in green indicating a message is waiting. Go to Web GUI → Account → General Settings to configure Voicemail Access Number.

To retrieve the voicemail:

- Press the Message hard key to dial into the voicemail box.
- Select an account and check the number of Normal/Urgent voicemails displayed on the screen. make operations according to the voice prompt.
- Press on dial soft key and follow the voice prompt to dial the Voicemail access number and password which is configured on the SIP server.
- Follow the voice prompt to read the awaiting messages or further operations.

The steps above are for the situation where two or three accounts are configured (GRP2602/GRP2603/GRP2604), if configured only one account, there is no need for users to select an account but go to the dial-up interface directly.

For each account, the Voicemail User ID can be set up under Web GUI → Account X → General Settings: "Voice Mail Access number". This is the number that will be dialed out to access voicemail messages when tapping on the account on the Voice Mail screen.

Call Features

The GRP260x supports traditional and advanced telephony features including caller ID, caller ID with caller Name, call forward, etc.

| | |
|-----|--|
| *30 | <p>Block Caller ID (for all subsequent calls)</p> <ul style="list-style-type: none"> ● Off hook the phone. ● Dial *30 |
|-----|--|

| | |
|-----|---|
| *31 | <p>Send Caller ID (for all subsequent calls)</p> <ul style="list-style-type: none"> ● Off hook the phone. ● Dial *31 |
| *50 | <p>Disable Call Waiting</p> <ul style="list-style-type: none"> ● Off hook the phone. ● Dial *50 |
| *51 | <p>Enable Call Waiting</p> <ul style="list-style-type: none"> ● Of hook the phone. ● Dial *51 |
| *67 | <p>Call with Caller ID Blocked (per call)</p> <ul style="list-style-type: none"> ● Off hook the phone. ● Dial *67 and then enter the number to dial out. |
| *82 | <p>Call with Caller ID Enabled (per call)</p> <ul style="list-style-type: none"> ● Off hook the phone. ● Dial *82 and then enter the number to dial out. |
| *70 | <p>Call with Call Waiting Disable (per call)</p> <ul style="list-style-type: none"> ● Off hook the phone. ● Dial *70 and then enter the number to dial out. |
| *71 | <p>Call with Call Waiting Enabled (per call)</p> <ul style="list-style-type: none"> ● Off hook the phone. ● Dial *82 and then enter the number to dial out. |
| *72 | <p>Unconditional Call Forward.</p> <ul style="list-style-type: none"> ● Off hook the phone. ● Dial *72 and then enter the number to forward the call. ● Press OK softkey or SEND key. |
| *73 | <p>Cancel Unconditional Call Forward. To cancel the unconditional call forward:</p> <ul style="list-style-type: none"> ● Off hook the phone. ● Dial *73. ● Hang up the call. |
| *90 | <p>Busy Call Forward. To set up busy call forward:</p> <ul style="list-style-type: none"> ● Off hook the phone. ● Dial *90 and then enter the number to forward the call. ● Press OK softkey or SEND key. |
| *91 | <p>Cancel Busy Call Forward. To cancel the busy call forward:</p> <ul style="list-style-type: none"> ● Off hook the phone. ● Dial *91. ● Hang up the call. |
| *92 | <p>Delayed Call Forward. To set up delayed call forward:</p> |

| | |
|-----|--|
| | <ul style="list-style-type: none"> ● Off hook the phone. ● Dial *92 and then enter the number to forward the call. ● Press OK softkey or SEND key. |
| *93 | <p>Cancel Delayed Call Forward. To cancel the delayed call forward:</p> <ul style="list-style-type: none"> ● Off hook the phone. ● Dial *93. ● Hang up the call. |

Call Features

Note

If the following feature codes do not work on your phone, please contact Administrator to turn on the "Enable Local Call Features" on phone's Web GUI. Enable Local Call Features is under phone's Web GUI→Account→Feature Codes tab.

CONTACTS

Local Contacts

The local contacts can save up to 2000 entries. Users can manage contacts by adding, deleting, and modifying single contacts, downloading contacts from HTTP/TFTP server, importing contacts from external storage, and exporting contacts to external storage.

For more details, please refer to the admin Guide:

<https://documentation.grandstream.com/knowledge-base/grp260x-series-administration-guide/>

Add a single Contact

On the Local Contacts menu, select Local Phonebook then press on Add contact softkey  and input

contact details such as First and last name, company/home/mobile numbers, and distinctive Ringtone ..., and then press the "Save" soft key. The new contact will be added to your local phonebook.

Phonebook

XML Phonebook syntax

Users can add contacts using the below syntax in the *phonebook.xml* file:







```
<AddressBook>
<Contact>
<id>3</id>
<FirstName>SAUL</FirstName>
<LastName>GOODMAN</LastName>
<Frequent>0</Frequent>
<Phone type="Work">
<phonenumber>45426</phonenumber>
<accountindex>0</accountindex>
</Phone>
<Phone type="Home">
<phonenumber>54786</phonenumber>
<accountindex>0</accountindex>
</Phone>
<Phone type="Cell">
<phonenumber>08789654</phonenumber>
<accountindex>0</accountindex>
</Phone>
<Primary>0</Primary>
<Company>GRANDSTREAM</Company>
<Department>SUPPORT</Department>
</Contact></AddressBook>
```

Download/Upload XML Phonebook from Web UI

From the phone's web interface **under Application → Contact → Phonebook Management**, Use the button "Download" to retrieve the XML phonebook currently configured on the phone. Press the button "Upload" to choose your XML phonebook to upload to the phone.

| | |
|---|--|
| Import Group Method ⓘ | <input type="text" value="Replace"/> |
| Sort Phonebook by ⓘ | <input type="text" value="Last Name"/> |
| Download XML Phonebook ⓘ | Download |
| Upload XML Phonebook ⓘ | Upload |
| Save Save and Apply Reset | |

Users can also input the "Company", "Title", and "Department" fields on the phonebook.xml like the previous example or through the phone's LCD by accessing contact and pressing the "Edit" soft key  to edit the contact and add extra information before saving the contact.

Note: When accessing the local phonebook, users could explore all available softkeys by pressing on "More" softkey , users could choose to look for a contact , Dial a contact number , Add New Contact , Block a contact number , delete a contact  or clear all contact list with  softkey.

XML Phonebook URLs

Users can configure Up to 3 XML Phonebooks URLs. This option can be found under device web GUI → Application → Remote phonebook.

| | Display Name | URL | Username | Password |
|-------------|----------------------|----------------------|----------------------|--------------------------|
| Phonebook 1 | <input type="text"/> | <input type="text"/> | <input type="text"/> | <input type="password"/> |
| Phonebook 2 | <input type="text"/> | <input type="text"/> | <input type="text"/> | <input type="password"/> |
| Phonebook 3 | <input type="text"/> | <input type="text"/> | <input type="text"/> | <input type="password"/> |

Remote Phonebook Update Interval(m) 

3XML Phonebook

CALL HISTORY

Local Call History

There are two categories in the local call history. Users could use LEFT/RIGHT navigation keys to switch between **All** calls Tab; **Missed** Calls Tab; **Dialed** Calls Tab; **Answered** Calls Tab and **Blocked** calls Tab. Below is the LCD icons indication for each type of call:

| | |
|---|----------|
|  | Dialed |
|  | Missed |
|  | Answered |
|  | Rejected |

Call History Icons

Call History Operations

- **Dial number from call history:** Press on dial softkey  to or Send key to dial the number. The phone will use the same account as the call log when dialing out.
- **Delete a number from call history:** Select an entry then press "Delete" soft key  to delete the call log.

- **/Clear call history:** Press on Clear All softkey  to clear the call history

Note

- When users miss a call, the GRP260x will show a notification on the LCD idle screen indicating that a call was missed, user can check the call history then by pressing on History softkey or ignore the notification by pressing on softkey 
- The call park feature in Broadsoft produces an audible alert and presents a visual notification.

DIAGNOSIS

Users could access the factory functions menu to diagnose the phone's hardware/software. To do so please access to LCD menu under **Factory Functions**.

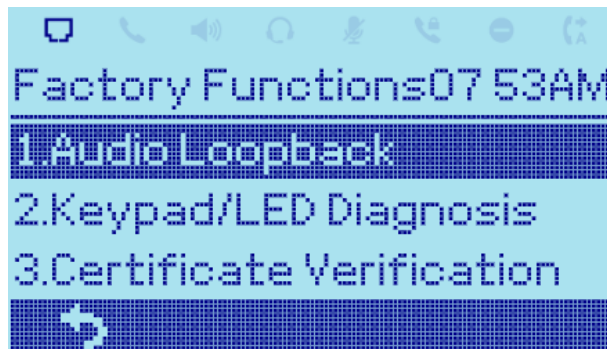

Factory Functions

These tools can be used to check the hardware and software status of the phone like verifying the LED, keypad buttons, Microphone/speaker functionality, certificate verification ...etc.

EHS HEADSET

The GRP260x supports a normal RJ9 headset jack (allowing EHS with Plantronics & Jabra & Sennheiser headsets).

Connect EHS Headset (Plantronics) to the GRP260x. To use headset mode, press the headset button on the phone. A headset icon  will show on the status bar. The EHS headset will ring when there is an incoming call.

RESTORE FACTORY DEFAULT SETTINGS

Warning

Restoring the Factory Default Settings will delete all configuration information on the phone. Please backup or print all the settings before you restore to the factory default settings. Grandstream is not responsible for restoring lost parameters and cannot connect your device to your VoIP service provider.

Restore factory settings using the LCD menu

Please follow the instructions below to reset the phone:

1. Press the MENU button to bring up the keypad configuration menu.
2. Navigate to Settings → Advanced Settings.
3. Select "Factory Reset".
4. A warning window will pop out to make sure a reset is requested and confirmed.

Press the "Yes" Softkey to confirm and the phone will reboot, or "No" Softkey to cancel the Reset.

Note

Warning messages displayed will automatically disappear from the LCD after a certain period of time.

Restore to Factory Default via Web GUI

1. Login GRP260X Web GUI.
2. Navigate to Maintenance → Upgrade and provisioning → Advanced Settings → Factory reset.
3. Press on **Start** Button situated against the Factory reset option

Click "OK" to confirm and the phone will reboot, or "Cancel" to cancel the Reset.

CHANGELOG

This section documents significant changes from previous versions of user manuals for GRP260x. Only major new features or major document updates are listed here. Minor updates for corrections or editing are not documented here.

Firmware Version 1.0.5.71

- No major changes.

Firmware Version 1.0.5.68

- No major changes.

Firmware Version 1.0.5.65

- Updated the term "Blacklist" to "Block List" on the LCD menu. [[Add Contact to Block list](#)][[Idle Screen](#)]

Firmware Version 1.0.5.60

- Added Support of Enhanced Call Park. [[Enhanced Call Park](#)]
- Added Support to configure PEAP 802.1x Settings from LCD Menu. [[Connecting to Wi-Fi Network](#)]
- Added Support to setup speed dial using the numeric keys on the keypad. [[Configuration via Keypad](#)]

Firmware Version 1.0.5.54

- No major changes.

Firmware Version 1.0.5.50

- No major changes.

Firmware Version 1.0.5.46

- No Major Changes

Firmware Version 1.0.5.38

- Improved device to clear warning icon automatically from the LCD after a certain period of time. [[Warning Messages](#)]
- Added support to have an LED signaling when receiving an incoming call. [[Receiving calls](#)]

Firmware Version 1.0.5.26

- No major changes.

Firmware Version 1.0.5.25

- Added Administrator authentication requirement when connecting to Wi-Fi from the LCD Menu on GRP2602W. [[Connecting to Wi-Fi Network](#)]
- Added Support to display call forward icon when the call forward is enabled by feature code from the device and also "Feature key sync" is enabled. [[Call Forwarding](#)]
- Added Support of SIP URI calls. [[SIP URI calls](#)]

Firmware Version 1.0.5.19

- No major changes.

Firmware Version 1.0.3.98

- Added Support to display Transfer softkey in call after enabling it in the Custom Call Screen Softkey Layout. [[Call Transfer](#)]

Firmware Version 1.0.3.87

- No major changes.

Firmware Version 1.0.3.86

- No major changes.

Firmware Version 1.0.3.83

Added Energy Saving mode Icon [[GRP260X LCD Icons](#)]

Firmware Version 1.0.3.72

- No major changes.

Firmware Version 1.0.3.70

- No major changes.

Firmware Version 1.0.3.63

- No major changes.

Firmware Version 1.0.3.59

- No major changes.

Firmware Version 1.0.3.57

- Added support to display the contacts when pressing the idle screen softkey "LDAP Search" before the search. [[LDAP Search](#)]
- Added support of remote phonebook as a call screen softkey. [[Remote Phonebook](#)]
- Improved Broadsoft call park indication by adding both display and sound notification. [[Broadsoft call park](#)]

Firmware Version 1.0.3.51

- Added support of an alert tone when the device is initiating a multicast paging. [[Initiating multicast paging](#)]
- Added support to have both header and name/number displayed on the LCD screen. [[Multiple SIP Accounts and Lines](#)]

Firmware Version 1.0.3.44

- Added Support of an alert tone when a multicast paging is received. [[Multicast paging recieved](#)]

Firmware Version 1.0.3.42

- No major changes

Firmware Version 1.0.3.31

- Added Ability to enable DND from web UI. [[DND](#)]

Firmware Version 1.0.3.18

- No major changes

Firmware Version 1.0.1.57

- No major changes

Firmware Version 1.0.1.50

- Added ability to finish an attended transfer by on-hooking the phone. [[Attended Transfer](#)]
- Added ability to return to the idle screen after you press the activated Line key. [[LINE key](#)]

Firmware Version 1.0.1.41

- Added VLAN tag settings on Device LCD menu. [[Figure 10: Keypad Menu Configuration Flow](#)]
- Added support to set up a Forward Always softkey on the idle screen. [[Softkeys in idle screen](#)]

Firmware Version 1.0.1.36

- No major changes.

Firmware Version 1.0.1.18

- This is the initial version for GRP260x.

COPYRIGHT

©2023 Grandstream Networks, Inc. <https://www.grandstream.com>

All rights reserved. Information in this document is subject to change without notice. Reproduction or transmittal of the entire or any part, in any form or by any means, electronic or print, for any purpose without the express written permission of Grandstream Networks, Inc. is not permitted.

Grandstream is a registered trademark and the Grandstream logo is the trademark of Grandstream Networks, Inc. in the United States, Europe, and other countries.

CAUTION

Changes or modifications to this product not expressly approved by Grandstream, or operation of this product in any way other than as detailed by this guide could void your manufacturer warranty.

WARNING

Please do not use a different power adaptor with devices as it may cause damage to the products and void the manufacturer warranty.

CERTIFICATION

U.S. FCC Part 68 Regulatory Information

This equipment complies with Part 68 of the FCC rules. Located on the equipment is a label that contains, among other information, the ACTA registration number and ringer equivalence number (REN). If requested, this information must be provided to the telephone company.

The REN is used to determine the quantity of devices which may be connected to the telephone line. Excessive REN's on the telephone line may result in the devices not ringing in response to an incoming call. In most, but not all areas, the sum of the REN's should not exceed five (5.0). To be certain of the number of devices that may be connected to the line, as determined by the total REN's contact the telephone company to determine the maximum REN for the calling area.

This equipment cannot be used on the telephone company-provided coin service. Connection to Party Line Service is subject to State Tariffs.

If this equipment causes harm to the telephone network, the telephone company will notify you in advance that temporary discontinuance of service may be required. If advance notice is not practical, the telephone company will notify the customer as soon as possible. Also, you will be advised of your right to file a complaint with the FCC if you believe it is necessary.

The telephone company may make changes in its facilities, equipment, operations, or procedures that could affect the operation of the equipment. If this happens, the telephone company will provide advance notice in order for you to make the necessary modifications in order to maintain uninterrupted service.

If any trouble experienced with this equipment, please contact (Agent in the US):

Company Name: Grandstream Networks, Inc.

Address: 126 Brookline Ave, 3rd Floor Boston, MA 02215, USA

Tel: 1-617-5669300

Fax: 1-617-2491987

If the trouble is causing harm to the telephone network, the telephone company may request you to remove the equipment from the network until the problem is resolved.

This equipment uses the following USOC jacks: RJ45C.

It is recommended that the customer install an AC surge arrester in the AC outlet to which this device is connected. This is to avoid damaging the equipment caused by local lightning strikes and other electrical surges.

Since this device has the HAC function, the earpiece is easy to absorb small, please take care to avoid scratching.

U.S. FCC Part 15 Regulatory Information

This device complies with part 15 of the FCC Rules. Operation is subject to the following two conditions:

(1) This device may not cause harmful interference, and (2) this device must accept any interference received, including interference that may cause undesired operation.

Any Changes or modifications not expressly approved by the party responsible for compliance could void the user's authority to operate the equipment.

Note: This equipment has been tested and found to comply with the limits for a Class B digital device, pursuant to part 15 of the FCC Rules. These limits are designed to provide reasonable protection against harmful interference in a residential installation. This equipment generates, uses, and can radiate radio

frequency energy and, if not installed and used in accordance with the instructions, may cause harmful interference to radio communications. However, there is no guarantee that interference will not occur in a particular installation. If this equipment does cause harmful interference to radio or television reception, which can be determined by turning the equipment off and on, the user is encouraged to try to correct the interference by one or more of the following measures:

- Reorient or relocate the receiving antenna.
- Increase the separation between the equipment and receiver.
- Connect the equipment into an outlet on a circuit different from that to which the receiver is connected.
- Consult the dealer or an experienced radio/TV technician for help.

This equipment complies with FCC radiation exposure limits set forth for an uncontrolled environment. This equipment should be installed and operated with minimum distance 20cm between the radiator & your body. This transmitter must not be co-located or operating in conjunction with any other antenna or transmitter.

Caution: Exposure to Radio Frequency Radiation

This equipment complies with EU radiation exposure limits set forth for an uncontrolled environment. This equipment should be installed and operated with minimum distance of 20 cm between the radiator and your body.

CE Authentication



| | | | | | | | | |
|----|----|----|----|----|----|--------|----|----|
| BE | BG | CZ | DK | DE | EE | IE | EL | LI |
| ES | FR | HR | IT | CY | LV | LT | LU | CH |
| HU | MT | NL | AT | PL | PT | RO | SI | TR |
| SK | FI | SE | NO | IS | UK | UK(NI) | | |

In the UK and EU member states, operation of 5150-5350 MHz is restricted to indoor use only.

Hereby, Grandstream Networks, Inc. declares that the radio equipment GRP2602W are in compliance with Directive 2014/53/EU.

The full text of the EU declaration of conformity is available at the following internet address:

<https://www.grandstream.com/support/resources/>

GNU GPL INFORMATION

GRP260x firmware contains third-party software licensed under the GNU General Public License (GPL). Grandstream uses software under the specific terms of the GPL. Please see the GNU General Public License (GPL) for the exact terms and conditions of the license.

Grandstream GNU GPL-related source code can be downloaded from the Grandstream website from:

<https://www.grandstream.com/legal/open-source-software>