



# User Guide

G.hn2400 Powerline AX1800 Wi-Fi 6 Kit  
PGW2440/PGW2445

# Contents

About This Guide .....	1
<b>Chapter 1. Get to Know Your Powerline Extender .....</b>	<b>3</b>
1.1. Product Overview.....	4
1.2. Product Appearance.....	4
<b>Chapter 2. Initial Use .....</b>	<b>6</b>
<b>Chapter 3. Configuring via Web Management Interface.....</b>	<b>10</b>
3.1. Management Interface.....	11
3.1.1. Log In .....	11
3.1.2. Change the Login Account .....	12
3.2. Manage Powerline Network .....	12
3.2.1. Change Powerline Network Name.....	12
3.2.2. Soft Pair.....	13
3.2.3. Compatibility Mode.....	14
3.3. Wi-Fi Move .....	15
3.4. Wi-Fi Clone .....	15
3.5. Wireless Network.....	16
3.5.1. Customize Wireless Settings .....	16
3.5.2. Wireless Clients .....	18
3.6. Schedule Your Wireless Function .....	19
3.7. Parental Controls .....	20
3.8. Guest Network.....	21
3.9. MAC Filter .....	22
3.10. Network .....	23
3.10.1. LAN Settings .....	23
3.10.2. DHCP Server .....	23
3.10.3. QoS.....	24
3.11. System.....	25
3.11.1. LED Control .....	25
3.11.2. Set Up System Time.....	25
3.11.3. Backup and Restore Configuration Settings.....	27
3.11.4. Upgrade the Firmware .....	28
3.11.5. Reboot Device.....	29

3. 11. 6. Change Login Password .....	30
3. 11. 7. System Log .....	30

**Chapter 4. OneMesh™ with Seamless Roaming..... 32**

4. 1. What's a OneMesh™ Network.....	33
4. 1. 1. Unified OneMesh™ Network.....	33
4. 2. How to Set Up a OneMesh™ Network .....	34





# About This Guide

This guide is a complement to Quick Installation Guide. The Quick Installation Guide provides instructions for quick internet setup, while this guide contains details of each function and demonstrates how to configure them in typical scenarios.

Features available in the powerline may vary by model and software version. Powerline availability may also vary by region or ISP. All images, steps, and descriptions in this guide are only examples and may not reflect your actual experience.

## Conventions

In this guide the following conventions are used:

Convention	Description
Powerline extender	Stands for G.hn2400 Powerline AX1800 Wi-Fi Extender without any explanation.
<u>Teal Underlined</u>	Hyperlinks are in teal and underlined. You can click to redirect to a website or a specific section.
Teal	Key information appears in teal, including management page text such as menus, items, buttons and so on.
>	The menu structures to show the path to load the corresponding page. For example, <a href="#">Wireless</a> > <a href="#">MAC Filter</a> means the MAC Filter function page is under the Wireless menu.
 Note:	Ignoring this type of note might result in a malfunction or damage to the device.
 Tips:	Indicates important information that helps you make better use of your device.
Symbols on the web page	<ul style="list-style-type: none"><li> click to edit the corresponding entry.</li><li> click to delete the corresponding entry.</li><li> click to enable or disable the corresponding entry.</li></ul>

\*G.hn devices are not compatible with HomePlug AV and AV2 Standard Powerline adapters. This product may not be compatible with routers or gateways with firmware that has been altered, is based on open source programs, or are non-standard or outdated.

\*Maximum Powerline signal rates are the physical rates derived from G.hn specifications. Actual Powerline data throughput and Powerline range are not guaranteed and will vary as a result of network conditions and environmental factors, including electrical interference, volume of traffic and network overhead, AFCI circuit breaker, and Powerline being located in a separate circuit.

\*The Power Saving feature takes effect when your appliances are disconnected or turned off. Actual power saving data will vary in different network conditions and environments.

## More Info

- The latest software, management app and utility are available from the [Download Center](https://www.tp-link.com/support/download) at <https://www.tp-link.com/support/download>.
- The Quick Installation Guide (QIG) can be found where you find this guide or inside the package of the powerline extender.
- Specifications can be found on the product page at <https://www.tp-link.com>.
- TP-Link Community is provided for you to share knowledge and discuss our products at <https://community.tp-link.com/>.
- Our Technical Support contact information can be found at the [Contact Technical Support](https://www.tp-link.com/support) page at <https://www.tp-link.com/support>.

## Chapter 1

---

# Get to Know Your Powerline Extender

---

This chapter introduces what the powerline extender can do and describes its main features and appearance.

It contains the following sections:

- ["Product Overview"](#)
- ["Product Appearance"](#)

## 1.1. Product Overview

TP-Link's Powerline Wi-Fi Extender is a combined wired/wireless network expansion device. With the help of your home's existing electrical circuitry, it can extend your Wi-Fi to wherever you want in your house.

With Ethernet ports and built-in antennas, the powerline Wi-Fi extender provides wired and wireless access for multiple computers and mobile devices.



With various features and functions, the powerline Wi-Fi extender is the perfect choice for your home or business network.

## 1.2. Product Appearance

Your powerline extender may differ in appearance slightly from that depicted because of the region and product version.

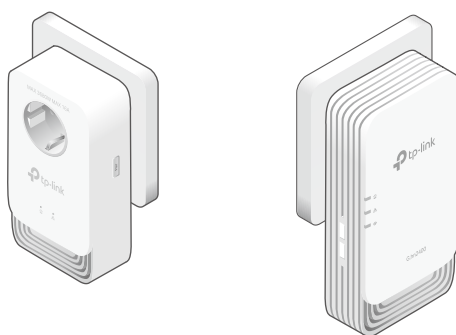
■ Note: The European version is used for demonstration in this User Guide.



Name	Status	Indication
 Powerline	Off	The powerline adapter is off.
	Blink Green	Quickly: The powerline adapter is pairing or upgrading firmware. Slowly: Power-Saving Mode is on.* (Only for PG2400P)
	Solid Orange	The powerline adapter is not connected to a powerline network.
	Solid Green	The powerline adapter is connected to a powerline network.
 Ethernet	On/Off	The Ethernet port is connected or not connected.
 Wireless	On	The wireless function is enabled.
	Blinking	The powerline extender is syncing wireless network settings.
	Off	The wireless function is disabled.

## Wi-Fi Button

Press for 1 second to start copying Wi-Fi settings from the router.

Press and hold for about 5 seconds to turn Wi-Fi on or off.

## Pair Button

Press and hold for 1 second to set up or join a secure powerline network.

Press and hold the Pair button for at least 6 seconds, then release the button to reset the adapter/extender to default settings.

## Ethernet Port

Connect the Ethernet ports to your wired devices, such as a computer, a router or a game console, via Ethernet cables.

## Integrated Electrical Socket

Used as a pass-through AC outlet to power other devices. It also reduces some electrical noise that may interfere with powerline performance.

**Note:**

1. Use the product in below directions.

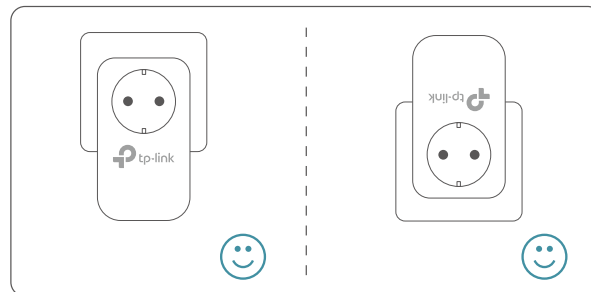

2. Plug the product directly into a wall socket instead of a power strip.

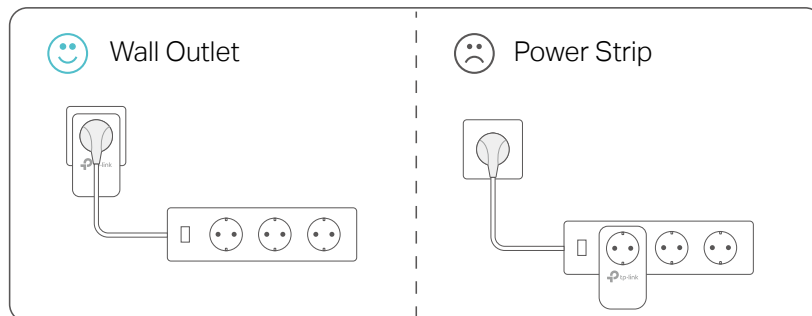



## Chapter 2

---

# Initial Use

---

This chapter guides you on how to use the powerline extender when you first open the package.

You can Use the Powerline Wi-Fi Kit to set up a new secure wireless network in my house. For example, I have a wireless router in my house, but the wireless signal cannot reach every corner. So I bought a Powerline Wi-Fi Kit to extend the wireless network. The Powerline Wi-Fi Kit includes a powerline adapter and a powerline extender.

**Note:** G.hn devices are not compatible with HomePlug AV and AV2 Standard Powerline adapters.

### Method 1: Plug and Play

1. Connect the powerline adapter to an available LAN port of the router.
2. Plug the powerline adapter into a wall socket.
3. Plug the powerline extender into a wall socket near the adapter. Wait until the extender's Powerline LED  turns solid green.

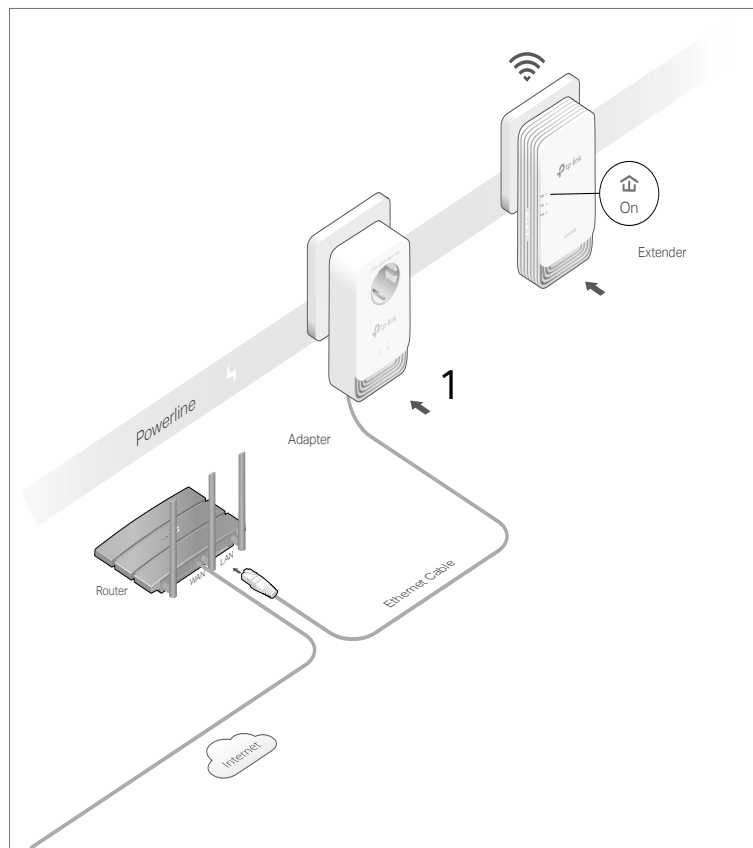

4. Relocate the new extender to the Wi-Fi "dead" zone. Connect your devices to the internet using the SSIDs (network name) and password printed on the label at the side of the extender.

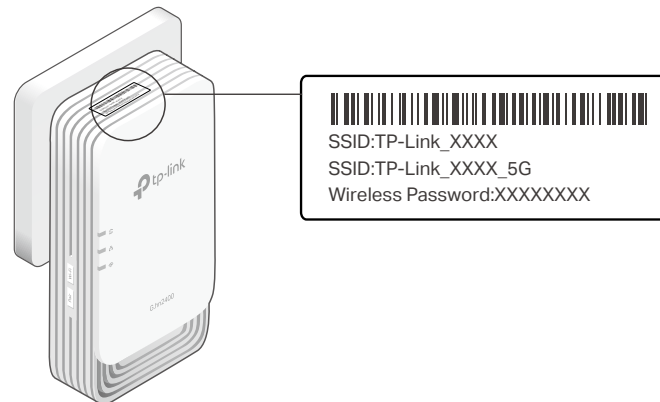

## Done!

Now enjoy the internet with the SSIDs and password printed on the label!

## Method 2: Pairing

1. Connect the powerline adapter to an available LAN port of the router.
2. Plug the powerline adapter into a wall socket.
3. Plug the powerline extender into a wall socket near the adapter.
4. Pair the powerline devices.
  - a . Press the Pair button of the powerline adapter for 1 second. The Powerline LED should start blinking green.
    - Note: If the Powerline LED does not blink, press the Pair button again.
  - b . (Within two minutes) press the Pair button of the powerline extender for 1 second. The Power LED should start blinking. When the extender's Powerline LED  turns solid green, the pairing process is done!



5. Relocate the new extender to the Wi-Fi "dead" zone. Connect your devices to the internet using the SSIDs (network name) and password printed on the label at the side of the extender.

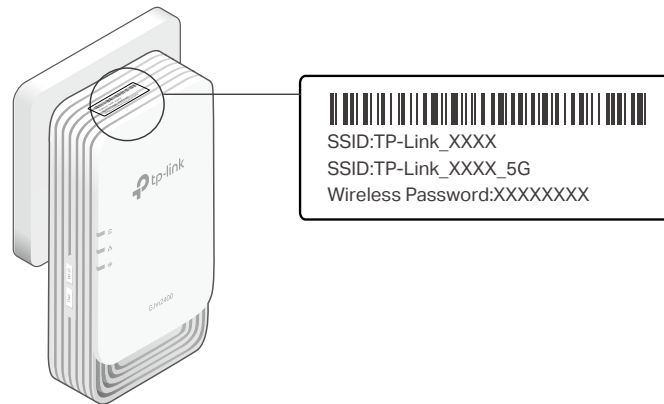

## Done!

Now enjoy the internet with the SSIDs and password printed on the label!

## Chapter 3

---

# Configuring via Web Management Interface

---

The powerline extender has a management interface to configure all settings. The management interface can be opened on any device that has a web browser, such as Internet Explorer, Chrome or Firefox. This chapter is going to give detailed information on what functions the powerline extender has and how to configure them.

It contains the following sections:

- [Management Interface](#)
- [Manage Powerline Network](#)
- [Wi-Fi Move](#)
- [Wi-Fi Clone](#)
- [Wireless Network](#)
- [Schedule Your Wireless Function](#)
- [Parental Controls](#)
- [Guest Network](#)
- [MAC Filter](#)
- [System](#)

## 3. 1. Management Interface

### 3. 1. 1. Log In

There are two methods to log in to the management interface.

- **Method 1: Via web browser**

Follow the steps below:

1. Connect your device to the powerline extender wirelessly.
2. Launch a web browser and type in <http://tplinkplc.net> to open the management interface.

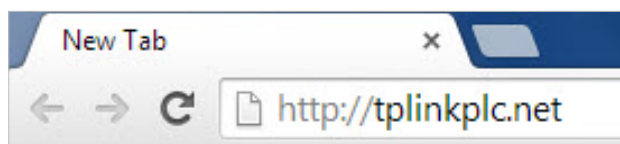

3. Create a password for future login attempts.

- **Method 2: Via tpPLC utility**

Follow the steps below:

1. Connect your computer to the powerline extender via an Ethernet cable or wirelessly.
2. Obtain and install the tpPLC Utility from the product's Support page at <https://www.tp-link.com>.
3. Open the utility, move your mouse over your powerline extender, and click the  icon that appears beside it.
4. Create a password for future login attempts.

- **Method 3: Via tpPLC app**

Follow the steps below:

1. Get the tpPLC app from the Apple App Store or Google Play, or simply scan the QR code.



2. Connect your device to the powerline extender wirelessly.
3. Launch the tpPLC app and find the model of your device.
4. Manage your powerline extender as needed.

### 3. 1. 2. Change the Login Account

Follow the steps below to change the account.

1. Go to [System > Administration](#).
2. Follow instructions on the page to set a new password. A strong password should be at least 8 characters in length, combining uppercase and lowercase letters, numbers and punctuations.

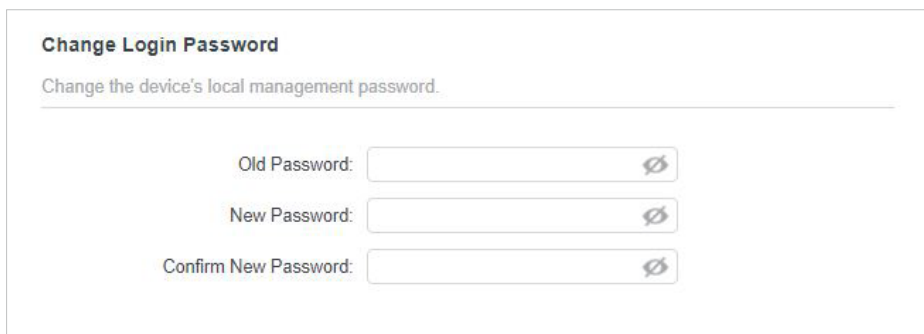

The screenshot shows a web form titled "Change Login Password" with the subtitle "Change the device's local management password." Below the subtitle is a horizontal line. There are three input fields, each with a label and a toggle icon (an eye with a slash) to its right: "Old Password:", "New Password:", and "Confirm New Password:".

3. Click [SAVE](#) to make the settings effective.

## 3. 2. Manage Powerline Network

A powerline network is formed of powerline devices, including adapters and extenders. Powerline devices in the same powerline network share the same powerline network name.

### 3. 2. 1. Change Powerline Network Name

You can change the extender's powerline network name to add it to or remove it from a powerline network.

Follow the steps below to change the name.

1. Connect to the powerline extender wirelessly. Visit <http://tplinkplc.net>, and log in with the password you set for the extender.
2. Go to [Powerline > Powerline Settings](#).

**Powerline**

View and configure your powerline settings. Devices using the same powerline network name will form a network.

---

MAC Address: 20-22-08-24-00-40

Device Name:

PowerLine Network Name:

**Note:** You can set up a powerline network by pushing the Pair button, using the [Soft Pair](#) feature, or manually setting the same powerline network name for each device.

[Reset Powerline Defaults](#)

3. Change the [Powerline Network Name](#). You can also click [Reset Powerline Defaults](#) to use the default network name, e.g. HomePlugAV. However, if the default name is used, the Wi-Fi Move function will be automatically disabled.
4. Click [Save](#) to make the settings effective.

### 3. 2. 2. Soft Pair

You can use the Soft Pair feature to pair this device with other powerline devices to form a powerline network, or leave a powerline network.

- **To form a powerline network.**
  1. Connect to the powerline extender wirelessly. Visit <http://tplinkplc.net>, and log in with the password you set for the extender.
  2. Go to [Powerline > Soft Pair](#).

**Soft Pair**

Pair with other powerline devices to form a powerline network.

---

**Note:** You can set up a powerline network by pushing the Pair button, using the Soft Pair feature, or manually setting the same [powerline network name](#) for each device.

How does pairing work? [?](#)

**To form a network:** Click the button below, then initiate pairing on another device within 2 minutes. Both devices will generate the same powerline network name to form a network.

[Start](#)



3. Click the **Start** button to initiate pairing on another device within 2 minutes. Both devices will generate the same powerline network name to form a network.

- **To leave a powerline network.**

1. Connect to the powerline extender wirelessly. Visit <http://tplinkplc.net>, and log in with the password you set for the extender.

2. Go to **Powerline > Soft Pair**.

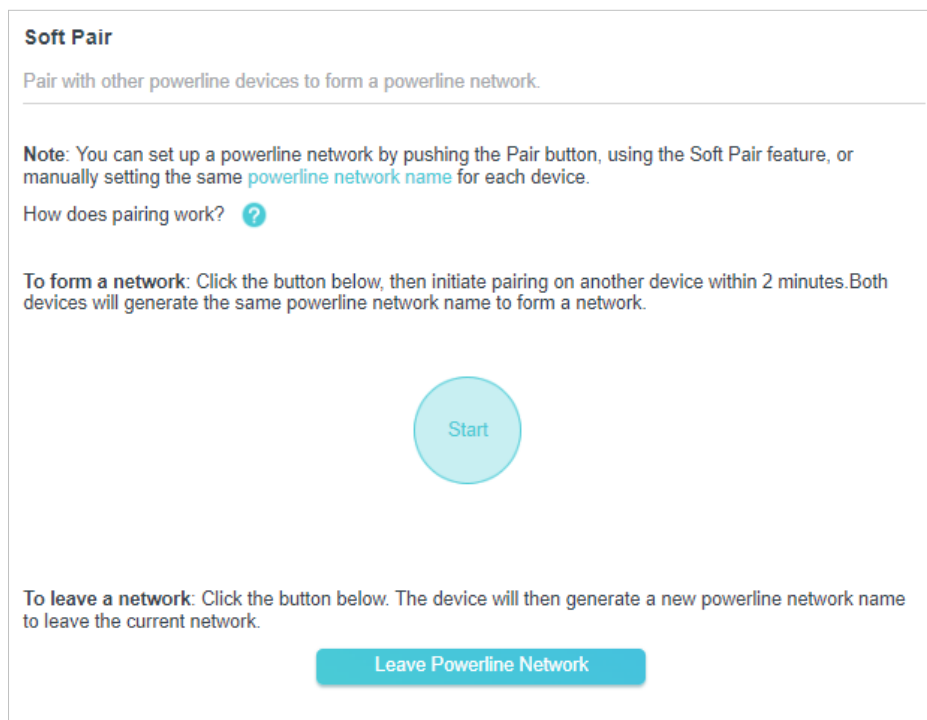

3. Click the **Leave Powerline Network** button. The device will then generate a new powerline network name to leave the current network.

### 3.2.3. Compatibility Mode

You can optimize the network communication of VDSL equipment in the powerline network. Automatic Compatibility is recommended in most cases.

1. Connect to the powerline extender wirelessly. Visit <http://tplinkplc.net>, and log in with the password you set for the extender.

2. Go to **Powerline > Compatibility Mode**, and enable it as needed.

**Compatibility Mode**

Optimize the network communication of VDSL equipment in the powerline network. Automatic Compatibility is recommended in most cases.

---

Automatic Compatibility:

In this mode, the device can automatically adjust the output signal to reduce network communication interference.

Note: In case your devices still have poor network communication, select the technical standard that matches your VDSL connection type with the help of your ISP.

Mode:  MIMO  
 SISO

Technical Standard:

### 3.3. Wi-Fi Move

Wi-Fi Move is enabled by default. With the feature enabled, any changes made to the Wi-Fi settings of one powerline extender will be automatically synchronized to other powerline extenders whose Wi-Fi Move feature is also enabled on the same powerline network .

Follow the steps below to enable the Wi-Fi Move feature:

1. Connect to the powerline extender wirelessly. Visit <http://tplinkplc.net>, and log in with the password you set for the extender.
2. Go to **Wi-Fi > Wi-Fi Move**.
3. Toggle **On** to enable the feature.

**Wi-Fi Move**

---

Note: Wi-Fi Move function synchronizes all Wi-Fi Settings, LED Schedule and Reboot Schedule. Please note that if the factory default **Powerline Network Name**, i.e. HomeGrid, is being used, the Wi-Fi Move feature will be automatically disabled.

Wi-Fi Move:

**Note:**

When Wi-Fi Move is enabled, the following features will be synced: Wireless SSID & Password, Wireless Security, Wireless Mode, Wireless Radio Status, Wi-Fi Schedules, LED Schedules, Wi-Fi Clone Settings, MAC Filter Settings, Parental Controls and Guest Network.

### 3.4. Wi-Fi Clone

You can copy wireless settings from your router to the extender, so you can use the same SSID and password to access the internet in your house.

1. Connect to the powerline extender wirelessly. Visit <http://tplinkplc.net>, and log in with the password you set for the extender.
2. Go to **Wi-Fi > Wi-Fi Clone**.
3. Select a Wi-Fi band or both to be cloned. **2.4GHz & 5GHz** is selected by default.

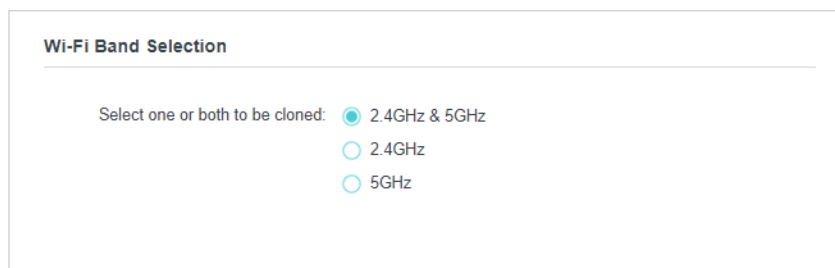

4. Before cloning, make sure your router supports the same band as your extender. If you do not know how to check this, go to your router's User Guide for more information.
5. Plug your extender near your router.
6. Press the **WPS** button on your router.

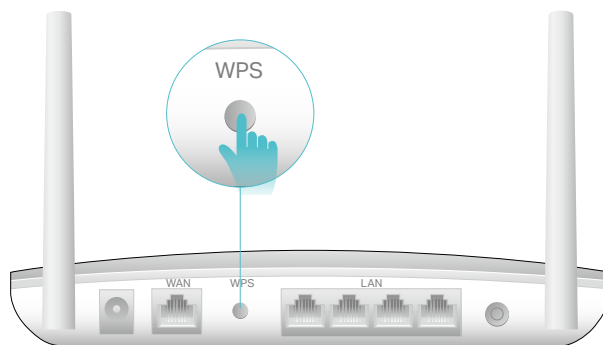

Wireless Router

7. Within two minutes, press the **Wi-Fi** button on the side panel of the extender. When the corresponding Wi-Fi LED blinks quickly for 3 seconds and then stays on. It's done!

## 3. 5. Wireless Network

### 3. 5. 1. Customize Wireless Settings

The powerline extender's wireless network name (SSID) and password, and security option are preset in the factory. The preset SSID and password can be found on the product label and Wi-Fi Info Card. You can customize the wireless settings according to your needs.

1. Connect to the powerline extender wirelessly. Visit <http://tplinkplc.net>, and log in with the password you set for the extender.
2. Go to **Wi-Fi > Wireless Settings** page.

### Wireless Settings

---

**2.4GHz Wireless:**  Enable [Sharing Network](#)

SSID:   Hide SSID

Security:

Version:

Encryption:

Password:

Channel:

Mode:

Channel Width:

Transmit Power:  High  Middle  Low

**5GHz Wireless:**  Enable [Sharing Network](#)

SSID:   Hide SSID

Security:

Version:

Encryption:

Password:

Channel:

Mode:

Channel Width:

Transmit Power:  High  Middle  Low

- **To enable or disable the wireless function:**

Select the box to enable the wireless Radio of 2.4GHz or 5GHz. Deselect the box to disable wireless function. If disabled, all wireless settings will be ineffective.

- **To change the wireless network name (SSID) and wireless password:**

The default SSID is TP-Link\_XXXX for 2.4GHz network and TP-Link\_XXXX\_5G for 5GHz network, and the default password is printed on the label at the side

panel of the extender. You can change the default ones by directly entering new ones in the field. SSID is up to 32 characters, and the value in both SSID and password is case-sensitive.

**Note:**

Remember to write down the new SSID and password, for you may be disconnected when new settings are effective.

- **To hide SSID:**

Select Hide SSID, and your SSID will not be broadcasted. It won't display when you scan for local wireless network list on your wireless device and you need to manually join the network.

- **To change other settings**

**Security:** Select an option from the Security drop-down list. The extender provides three options, No Security, WPA/WPA2 Personal (Recommended), and WEP. WPA2 uses the newest standard and the security level is the highest. We don't recommend you to change the default settings unless necessary.

**Channel:** Select the channel you want to use from the drop-down list. This field determines which operating frequency will be used. It is not necessary to change the wireless channel unless you notice interference problems with another nearby access point.

**Mode:** Select the desired mode from the dropdown list.

**Channel Width:** Select the channel width. The default setting is Auto, which can adjust the channel width for your clients automatically.

**Transmit Power:** Select the level of transmit power. We recommend you choose High to have the best signal strength.

### 3.5.2. Wireless Clients

Follow the steps below to view detailed information of all wireless clients connected to the extender.

1. Connect to the powerline extender wirelessly. Visit <http://tplinkplc.net>, and log in with the password you set for the extender.
2. Go to **Wi-Fi > Clients** page.

Online Wireless Clients					
Total Clients: 1					 Refresh
ID	Device Name	IP Address	MAC Address	Wireless Band	Security
1	TP-Link	192.168.0.101	CC-08-8D-19-0A-35	2.4GHz	WPA2-PSK

3. Now you can view the detailed information, including device name, IP address, MAC address, connected wireless band and security type.

**Tips:** You can also see the wireless details by clicking the wireless clients icon on [Status > Wireless Clients](#).

## 3.6. Schedule Your Wireless Function

You can automatically turn off your wireless network at times when you do not need the wireless connection.

1. Connect to the powerline extender wirelessly. Visit <http://tplinkplc.net> and log in with the password you set.
2. Go to [Wi-Fi > Wi-Fi Schedule](#).

**WiFi Schedule**  
Schedule when to automatically turn off your extender.

WiFi Schedule:

Do not turn off WiFi while clients are connected to it

**Note:** Before enabling WiFi Schedule, please make sure the [Time Settings](#) is correct.

Current Time: 01/01/2022 00:34:33

[+ Add](#)

WiFi Off Time	Repeat	Status	Modify
21:00 - 09:00 (next day)	Mon, Tue, Wed, Thu, Fri	<input checked="" type="checkbox"/>	<a href="#">Edit</a> <a href="#">Delete</a>

3. Toggle **On** to enable the Wi-Fi Scheduler. If you are prompted like the following picture, click **Continue**.

Changes made to Wi-Fi Settings, LED Schedule and Reboot Schedule will be synchronized across powerline extenders whose Wi-Fi Move function is enabled. Are you sure you want to continue?

[Cancel](#) [OK](#)

4. Check the box of **Do not turn off Wi-Fi while clients are connected to it**.
5. Click **Add** to add an entry.
6. Choose the time period from the drop-down list and check the days.

**Note:** Please make sure that the system time is correct before using this function.

7. Click [Enable this entry](#) to make it effective.

**Note:**

The Wi-Fi LED will turn off if the wireless network is disabled.

## 3.7. Parental Controls

You can control when your children's wireless devices can access the internet.

1. Connect to the powerline extender wirelessly. Visit <http://tplinkplc.net>, and log in with the password you set for the extender.
2. Go to [Wi-Fi > Parental Controls](#). Toggle [On](#) to enable Parental Controls.

**Parental Controls**

Note: Make sure [Time Settings](#) are correct before using this function.

Parental Controls:

**Devices Under Parental Controls**

[+ Add](#)

ID	MAC Address	Internet Access Time	Description	Status	Modify
No Entries					

3. Click [Add](#).

**Add** ×

Select From Device List

Add Manually

MAC Address:

Internet Access Time: From

To

Repeat:  S  M  T  W  T  F  S

Description:

4. Select the device from device list to be controlled. Or, enter the [MAC Address](#) manually.

5. Set **Internet Access Time**, and select which days to repeat.

▀ **Note:** Please make sure that the system time is correct before using this function.

6. Enter a **Description** for the entry.

7. Click **SAVE** to save the settings.

## 3.8. Guest Network

**You can** create a network for your guests, providing internet access for them while at the same time limit the network authorities for guests to ensure network security and privacy.

1. Connect to the powerline extender wirelessly. Visit <http://tplinkplc.net>, and log in with the password you set for the extender.

2. Go to **Wi-Fi > Guest Network**.

3. Check the box of relative entry to limit network authorities. If you have problems understanding these items, click the question mark on the upper right corner to have more information.

4. Click **SAVE** to make the settings effective.

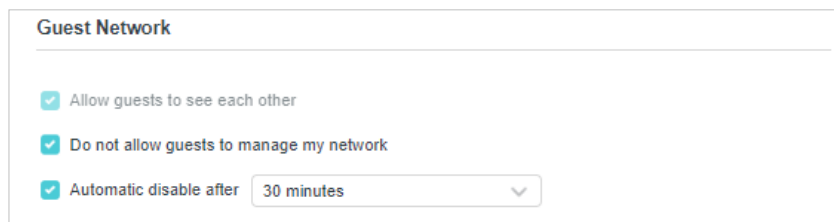

Guest Network

- Allow guests to see each other
- Do not allow guests to manage my network
- Automatic disable after 30 minutes

5. Select **2.4GHz** or **5GHz** to choose a wireless band, and configure the following settings.

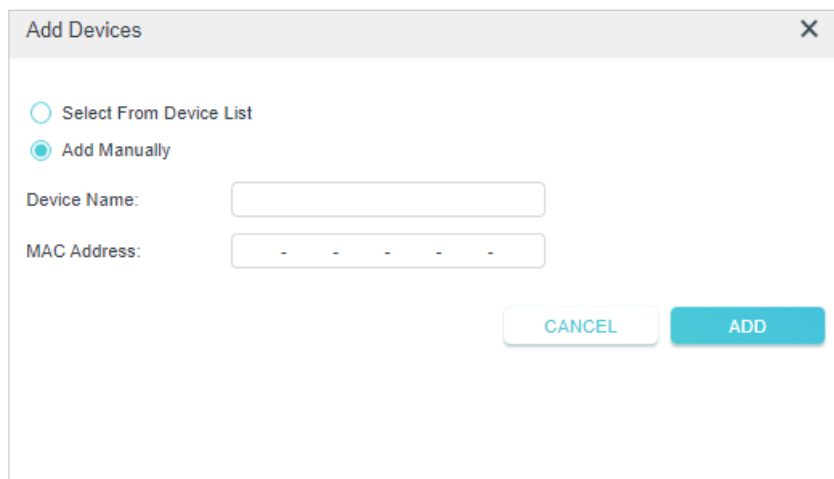

Add Devices

Select From Device List

Add Manually

Device Name:

MAC Address:

CANCEL ADD

- **To change the guest network name (SSID) and password:**



The default SSID is TP-Link\_Guest\_XXXX for 2.4GHz guest network and TP-Link\_Guest\_XXXX\_5G for 5GHz guest network. The default password is the same as the host network's, which is printed on the label at the back panel of the extender. You can change the default ones by directly entering new ones in the field. SSID is up to 32 characters, and the value in both SSID and password is case-sensitive.

## 3.9. MAC Filter

This function exploits the uniqueness of the MAC (Medium Access Control) address, a unique 12-digit hexadecimal address (for example, D8-5D-4C-B4-46-EA) of every network device, to determine if the device can or cannot access your wireless network.

1. Connect to the powerline extender wirelessly. Visit <http://tplinkplc.net>, and log in with the password you set for the extender.
2. Go to **Wi-Fi** > **MAC Filter**.
3. Toggle **On** to enable MAC Filter.
4. Select either of the filtering rules.

MAC Filter

MAC Filter:

Select the filtering rule:  Deny List  
Deny access to your network from the specified devices.  
 Allow List

+ Add

Device Type	Device Name	MAC Address	Modify
No Entries			

5. Select from the device list or add the device manually by entering its MAC address, then click **ADD**.

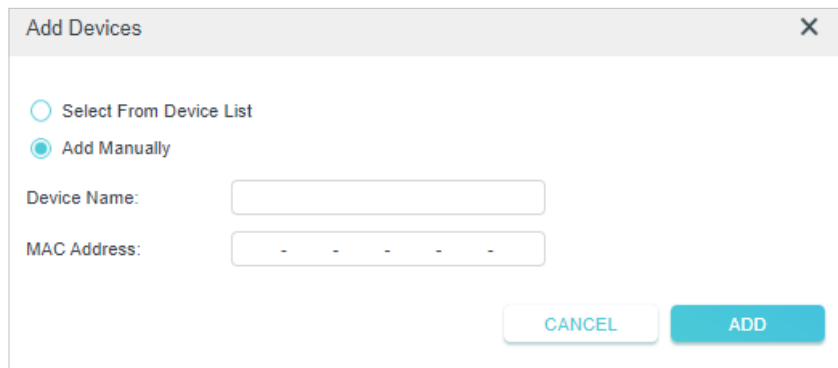

Add Devices

Select From Device List

Add Manually

Device Name:

MAC Address:

CANCEL ADD

## 3. 10. Network

### 3. 10. 1. LAN Settings

Follow the steps below to configure LAN settings of the extender.

1. Connect to the powerline extender wirelessly. Visit <http://tplinkplc.net>, and log in with the password you set for the extender.
2. Go to **Network > LAN Settings**.

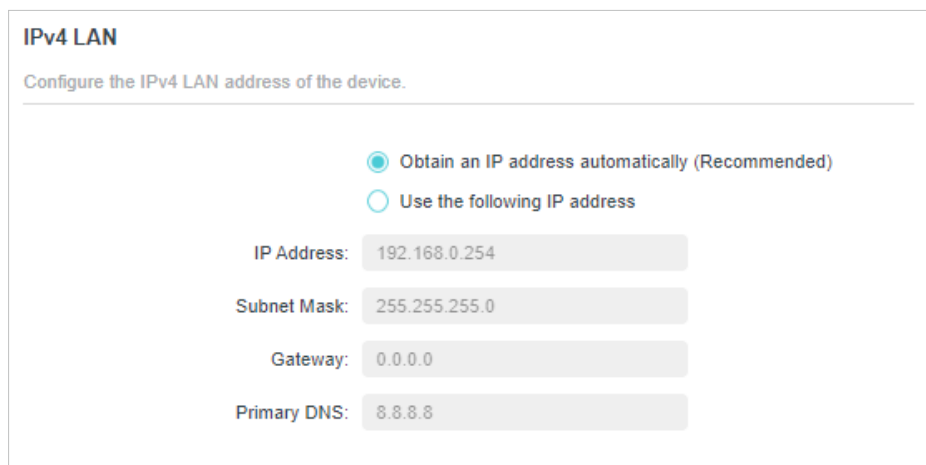

IPv4 LAN

Configure the IPv4 LAN address of the device.

Obtain an IP address automatically (Recommended)

Use the following IP address

IP Address:

Subnet Mask:

Gateway:

Primary DNS:

Select to have your extender automatically obtain IP Address from the main router or select to manually configure the LAN parameters.

**IP Address:** The IP address of the powerline extender.

**Subnet Mask:** The subnet mask associated with IP address.

**Default Gateway:** The IP address of the gateway device.

### 3. 10. 2. DHCP Server

Follow the steps below to configure DHCP Server of the extender.

1. Connect to the powerline extender wirelessly. Visit <http://tplinkplc.net>, and log in with the password you set for the extender.
2. Go to **Network > DHCP Server**. Select the DHCP server type and configure the settings. If you select **Auto**, the DHCP server of this extender will be turned off if there is already a DHCP server in the network.

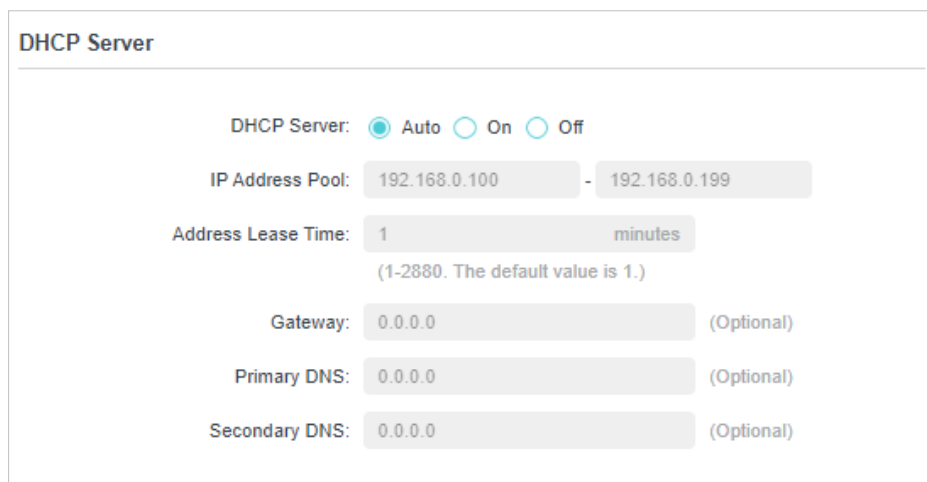

### 3. 10. 3. QoS

You can choose to prioritize the online activity that's most important to everyone on the network.

Follow the steps below to configure the QoS feature of the extender.

1. Connect to the powerline extender wirelessly. Visit <http://tplinkplc.net>, and log in with the password you set for the extender.
2. Go to **Network > QoS**. Select the QoS mode to prioritize the corresponding activity.

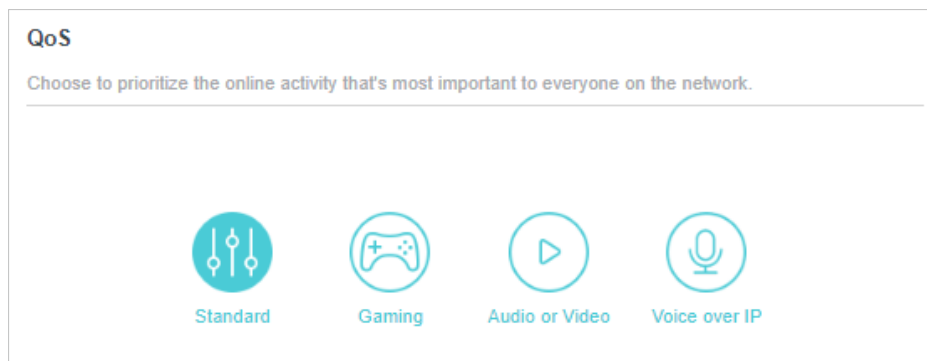

## 3. 11. System

### 3. 11. 1. LED Control

The LED of the extender indicates its activities and status. You can enable the Night Mode feature to specify a time period during which the LED is off.

1. Connect to the powerline extender wirelessly. Visit <http://tplinkplc.net>, and log in with the password you set for the extender.
2. Go to [System](#) > [LED Control](#) page. Toggle On LED Status.

**LED Control**  
Turn the PLC's LEDs on or off.

LED Status:

**Night Mode**  
Set a time period when the LEDs will be off automatically.

Night Mode:  Enable

Note: Make sure [Time Settings](#) are correct before using this function.

Current Time: 01/01/2022 00:56:03

LED Off From: 00 : 00

To: 00 : 00 (next day)

3. Enable [Night Mode](#). Specify the LED off time, and the LED will be off during this period every day.

### 3. 11. 2. Set Up System Time

System time is the time displayed while the extender is running. The system time you configure here will be used for other time-based functions like Parental Controls, Wi-Fi Schedules. You can manually set how to get the system time.

1. Connect to the powerline extender wirelessly. Visit <http://tplinkplc.net>, and log in with the username and password you set for the extender.
2. Go to [System](#) > [Time Settings](#) page.

### System Time

Set the extender's system time.

---

Current Time: 01/01/2022 00:49:14

24-Hour Time:

Set Time:

Time Zone:

NTP Server I:  (Optional)

NTP Server II:  (Optional)

---

### Daylight Saving Time

Automatically synchronize the system time with daylight saving time.

---

Daylight Saving Time:  Enable

Start:2022

End:2022

Running Status: Daylight Saving Time is off.

- **To automatically synchronize the time:**
  1. Select your local [Time Zone](#) from the drop-down menu.
  2. In the [NTP Server I](#) field, enter the IP address or domain name of your desired NTP Server. (Optional)
  3. In the [NTP Server II](#) field, enter the IP address or domain name of the second NTP Server. (Optional)
  4. Click [Get GMT](#) and click [Save](#).
- **To manually set the date and time:**
  1. In the [Time Settings](#) field, select your local [Time Zone](#).
  2. Enter the current [Date](#).
  3. Set the current [Time](#) (In 24-hour clock format, e.g. 16:00:00 is 04:00PM).
  4. Click [Save](#).
- **To set up Daylight Saving time:**

1. Enable [Daylight Saving Time](#).
2. Select the correct [Start](#) date and time when daylight saving time starts at your local time zone.
3. Select the correct [End](#) date and time when daylight saving time ends at your local time zone.
4. Click [SAVE](#).

### 3. 11. 3. Backup and Restore Configuration Settings

The configuration settings are stored as a configuration file in the extender. You can back up the configuration file to your computer for future use and restore the extender to a previous settings from the backup file when needed. Moreover, if needed, you can erase the current settings and reset the extender to the default factory settings.

- **To back up configuration settings:**

1. Connect to the powerline extender wirelessly. Visit <http://tplinkplc.net>, and log in with the password you set for the extender.
2. Go to [System](#) > [Backup & Restore](#) > [Backup](#) page.

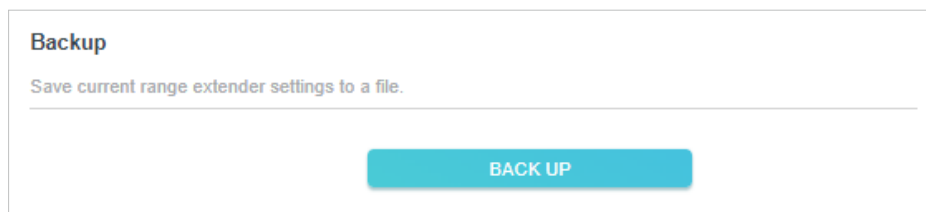

The screenshot shows a web interface titled "Backup". Below the title is the instruction "Save current range extender settings to a file." followed by a horizontal line. At the bottom center of the page is a large teal button labeled "BACK UP".

3. Click [BACKUP](#) to save a copy of the current settings to your local computer. A [config.bin](#) file will be stored to your computer.

- **To restore configuration settings:**

1. Connect to the powerline extender wirelessly. Visit <http://tplinkplc.net>, and log in with the password you set for the extender.
2. Go to [System](#) > [Backup & Restore](#) > [Restore](#) page.

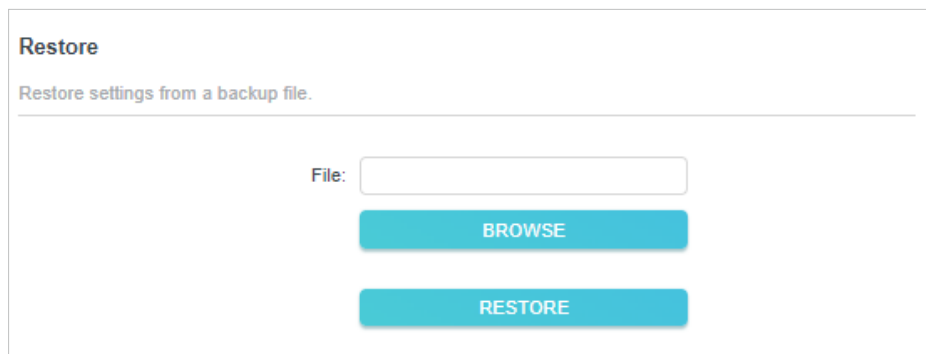

The screenshot shows a web interface titled "Restore". Below the title is the instruction "Restore settings from a backup file." followed by a horizontal line. Below the line is a "File:" label next to an empty text input field. Underneath the input field are two teal buttons: "BROWSE" and "RESTORE".

3. Click **BROWSE** to locate the backup configuration file stored on your computer, and click **RESTORE**. The configuration file is config.bin.

4. Wait a few minutes for the restoring and rebooting.

■ **Note:** During the restoring process, do not turn off or reset the extender.

- **To reset the extender to factory default settings:**

1. Connect to the powerline extender wirelessly. Visit <http://tplinkplc.net>, and log in with the password you set for the extender.

2. Go to **System > Backup & Restore > Factory Default Restore** page.

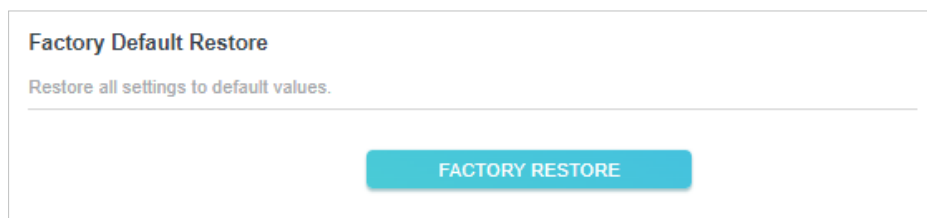

3. Click **FACTORY RESTORE** to reset the extender.

4. Wait a few minutes for the resetting and rebooting.

■ **Note:**

1. During the resetting process, do not turn off the extender.

2. We strongly recommend you back up the current configuration settings before resetting the extender.

### 3. 11. 4. Upgrade the Firmware

TP-Link is dedicated to improving and enriching the product features, giving you a better network experience. We will release the latest firmware at TP-Link official website, you can download the latest firmware file from our website: [www.tp-link.com](http://www.tp-link.com) and upgrade the firmware to the latest version.

1. Connect to the powerline extender wirelessly. Visit <http://tplinkplc.net>, and log in with the username and password you set for the extender.

2. Go to **System > Firmware Upgrade** page and confirm the **Hardware Version**.

**Firmware Upgrade**

Upgrade firmware from a local file.

Select your upgrade file, then click Upgrade.

Hardware Version: .....

Firmware Version: .....

New Firmware File:

**BROWSE**

**UPGRADE**

3. Go to [www.tp-link.com](http://www.tp-link.com). Download the latest firmware file for the extender.

■ **Note:** The upgraded firmware version must correspond to the hardware.

4. Click **BROWSE** to locate the downloaded new firmware file, and click **UPGRADE**.

5. Wait a few minutes for the upgrading and rebooting.

■ **Note:**

1. Before upgrading the firmware, it's better to back up your current settings.
2. During the upgrading process, do not turn off or reset the extender.

### 3.11.5. Reboot Device

You can manually reboot the device or schedule the reboot to clean the cache to enhance the running performance of the router..

1. Connect to the powerline extender wirelessly. Visit <http://tplinkplc.net>, and log in with the password you set for the extender.
2. Go to **System > Reboot** page.



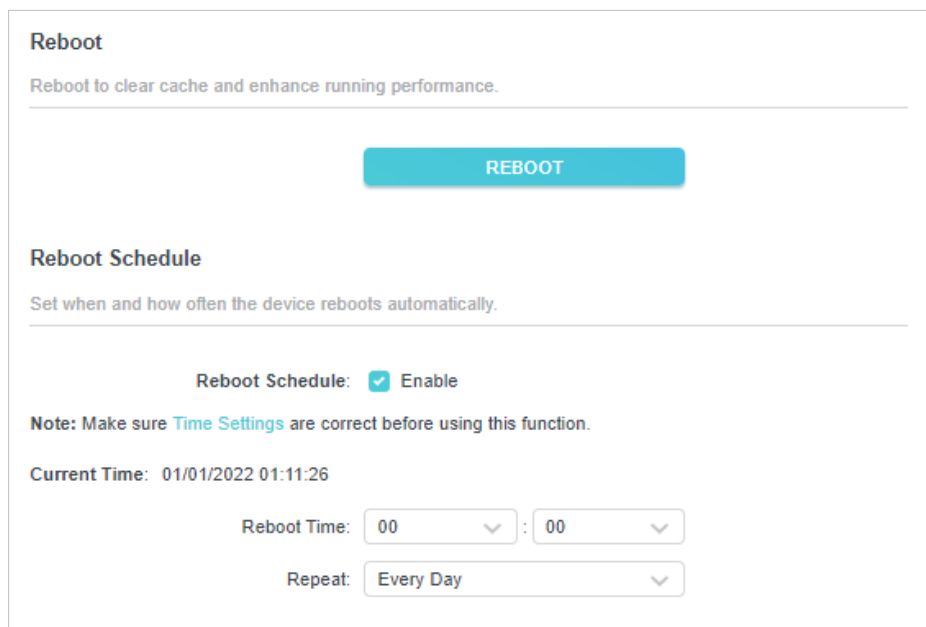

**Reboot**  
Reboot to clear cache and enhance running performance.

**REBOOT**

**Reboot Schedule**  
Set when and how often the device reboots automatically.

Reboot Schedule:  Enable

Note: Make sure [Time Settings](#) are correct before using this function.

Current Time: 01/01/2022 01:11:26

Reboot Time: 00 : 00

Repeat: Every Day

3. Enable [Reboot Schedule](#). Specify the [Reboot Time](#) when the router reboots and [Repeat](#) to decide how often it reboots.

### 3. 11. 6. Change Login Password

Follow the steps below to change the login password:

1. Connect to the powerline extender wirelessly. Visit <http://tplinkplc.net>, and log in with the password you set for the extender.
2. Go to [System > Change Login Password](#).

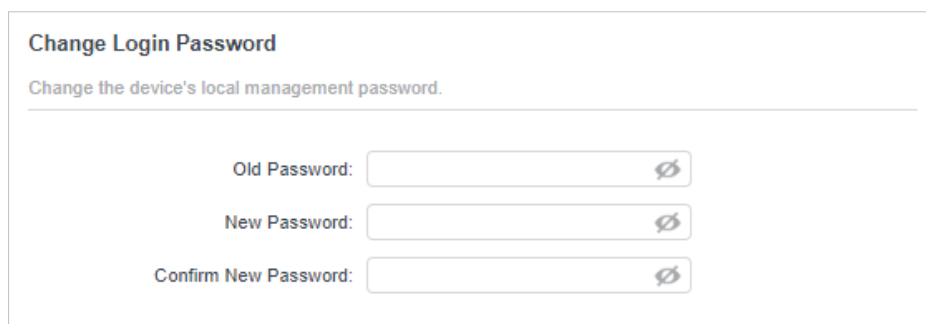

**Change Login Password**  
Change the device's local management password.

Old Password:

New Password:

Confirm New Password:

3. Enter the old password and set the new password..

### 3. 11. 7. System Log

When the extender does not work properly, you can save the system log and send it to the technical support for troubleshooting.

Follow the steps below to save the system log:

1. Connect to the powerline extender wirelessly. Visit <http://tplinkplc.net>, and log in with the password you set for the extender.
2. Go to [System](#) > [System Log](#).

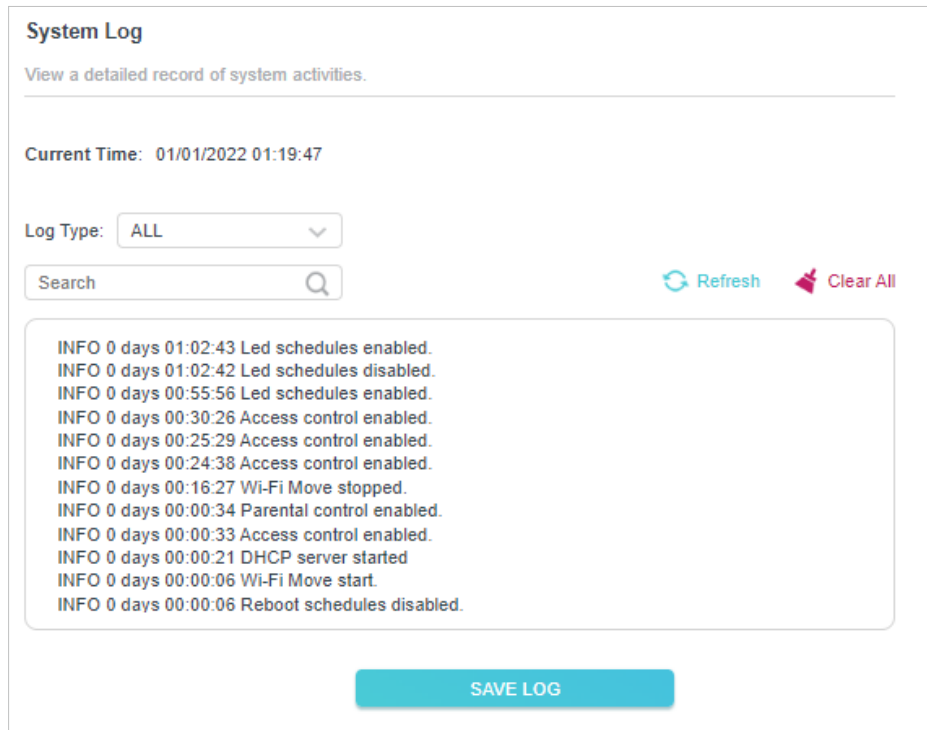

3. Choose the type and level of the system log according to your need.
4. Click [SAVE LOG](#) to save the system log to local.

## Chapter 4

---

# OneMesh™ with Seamless Roaming



---

This chapter introduces the TP-Link OneMesh™ feature.

It contains the following sections:

- [What's a OneMesh™ Network](#)
- [How to Set Up a OneMesh™ Network](#)

## 4. 1. What's a OneMesh™ Network

TP-Link OneMesh™  router and TP-Link OneMesh™  extenders work together to form one unified Wi-Fi network. Walk through your home and stay connected with the fastest possible speeds thanks to OneMesh's seamless coverage.

### Unified Wi-Fi Network

Router and extenders share the same wireless settings, including network name, password and more.

### Seamless Roaming

Devices automatically switch between your router and extenders as you move through your home for the fastest possible speeds.

### Easy Setup and Management

Easily set up and manage a unified OneMesh™ network.

To check full list of TP-Link OneMesh™ devices, visit <https://www.tp-link.com/One-Mesh/compatibility>.

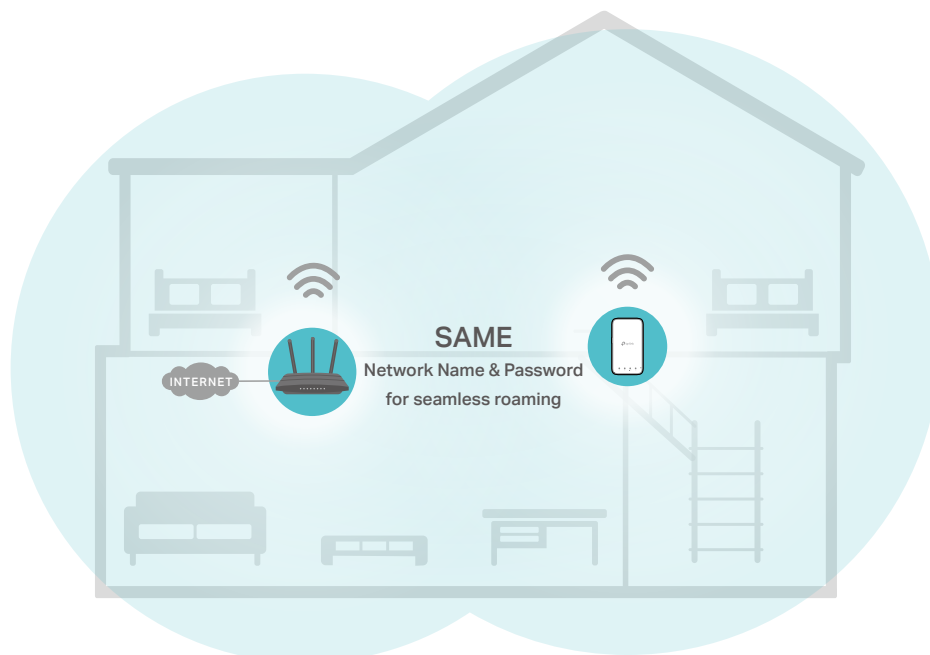

### 4. 1. 1. Unified OneMesh™ Network



## 4.2. How to Set Up a OneMesh™ Network

You can manage all mesh devices in the OneMesh™ network all on your router's web page.

Follow the steps below to create a OneMesh™ network.

1. Connect the extender to your computer wirelessly. Visit <http://tplinkplc.net>, and log in with the password you set for the extender.
2. Go to  OneMesh and toggle on **Join OneMesh**. When the extender's 2.4 GHz and 5 GHz Wi-Fi LEDs  turn solid on, Wi-Fi settings are copied.

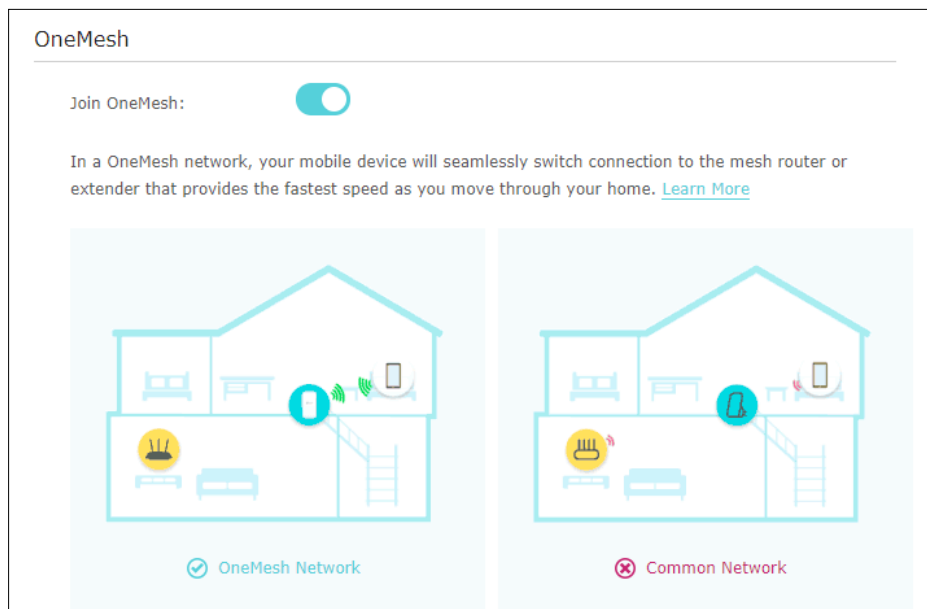

**Note:** This function is available only when your extender is connected to a OneMesh™ Router.

3. Enjoy the internet using your router's SSID and password.

## FCC compliance information statement



Product Name: G.hn2400 Passthrough Powerline Adapter

Model Number: PG2400P

Responsible party:

TP-Link USA Corporation

Address: 10 Mauchly, Irvine, CA 92618

Website: <http://www.tp-link.com/us/>

Tel: +1 626 333 0234

Fax: +1 909 527 6804

E-mail: [sales.usa@tp-link.com](mailto:sales.usa@tp-link.com)

This equipment has been tested and found to comply with the limits for a Class B digital device, pursuant to part 15 of the FCC Rules. These limits are designed to provide reasonable protection against harmful interference in a residential installation. This equipment generates, uses and can radiate radio frequency energy and, if not installed and used in accordance with the instructions, may cause harmful interference to radio communications. However, there is no guarantee that interference will not occur in a particular installation. If this equipment does cause harmful interference to radio or television reception, which can be determined by turning the equipment off and on, the user is encouraged to try to correct the interference by one or more of the following measures:

- Reorient or relocate the receiving antenna.
- Increase the separation between the equipment and receiver.
- Connect the equipment into an outlet on a circuit different from that to which the receiver is connected.
- Consult the dealer or an experienced radio/ TV technician for help.

This device complies with part 15 of the FCC Rules. Operation is subject to the following two conditions:

1. This device may not cause harmful interference.
2. This device must accept any interference received, including interference that may cause undesired operation.

Any changes or modifications not expressly approved by the party responsible for compliance could void the user's authority to operate the equipment.

We, TP-Link USA Corporation, has determined that the equipment shown as above has been shown to comply with the applicable technical standards, FCC part 15. There is no unauthorized change is made in the equipment and the equipment is properly maintained and operated.



Product Name: G.hn2400 Powerline AX1800 Wi-Fi 6 Extender

Model Number: PGW2440

Responsible party:

TP-Link USA Corporation

Address: 10 Mauchly, Irvine, CA 92618

Website: <https://www.tp-link.com/us/>

Tel: +1 626 333 0234

Fax: +1 909 527 6804

E-mail: [sales.usa@tp-link.com](mailto:sales.usa@tp-link.com)

This equipment has been tested and found to comply with the limits for a Class B digital device, pursuant to part 15 of the FCC Rules. These limits are designed to provide reasonable protection against harmful interference in a residential installation. This equipment generates, uses and can radiate radio frequency energy and, if not installed and used in accordance with the instructions, may cause harmful interference to radio communications. However, there is no guarantee that interference will not occur in a particular installation. If this equipment does cause harmful interference to radio or television reception, which can be determined by turning the equipment off and on, the user is encouraged to try to correct the interference by one or more of the following measures:

- Reorient or relocate the receiving antenna.
- Increase the separation between the equipment and receiver.
- Connect the equipment into an outlet on a circuit different from that to which the receiver is connected.
- Consult the dealer or an experienced radio/ TV technician for help.

This device complies with part 15 of the FCC Rules. Operation is subject to the following two conditions:

1. This device may not cause harmful interference.
2. This device must accept any interference received, including interference that may cause undesired operation.

Any changes or modifications not expressly approved by the party responsible for compliance could void the user's authority to operate the equipment.

Note: The manufacturer is not responsible for any radio or TV interference caused by unauthorized modifications to this equipment. Such modifications could void the user's authority to operate the equipment.

### **FCC RF Radiation Exposure Statement**

This equipment complies with FCC RF radiation exposure limits set forth for an uncontrolled environment. This device and its antenna must not be co-located or operating in conjunction with any other antenna or transmitter.

"To comply with FCC RF exposure compliance requirements, this grant is applicable to only Mobile Configurations. The antennas used for this transmitter must be installed to provide a separation distance of at least 20 cm from all persons and must not be co-located or operating in conjunction with any other antenna or transmitter."

We, TP-Link USA Corporation, has determined that the equipment shown as above has been shown to comply with the applicable technical standards, FCC part 15. There is no unauthorized change is made in the equipment and the equipment is properly maintained and operated.

Issue Date: 2022.10.26

### **CE Mark Warning**



This is a class B product. In a domestic environment, this product may cause radio interference, in which case the user may be required to take adequate measures.

### **For PG2400P**

### **EU Declaration of Conformity**

TP-Link hereby declares that the device is in compliance with the essential requirements and other relevant provisions of directives 2014/30/EU, 2014/35/EU, 2009/125/EC, 2011/65/EU and (EU)2015/863.

The original EU declaration of conformity may be found at <https://www.tp-link.com/en/support/ce/>

### **For PGW2440**

### **OPERATING FREQUENCY(the maximum transmitted power)**

2400 MHz -2483.5 MHz (20dBm)

5150 MHz -5250 MHz (23dBm)



## EU Declaration of Conformity

TP-Link hereby declares that the device is in compliance with the essential requirements and other relevant provisions of directives 2014/53/EU, 2009/125/EC, 2011/65/EU and (EU)2015/863.

The original EU declaration of conformity may be found at <https://www.tp-link.com/en/ce>

## RF Exposure Information

This device meets the EU requirements (2014/53/EU Article 3.1a) on the limitation of exposure of the general public to electromagnetic fields by way of health protection.

The device complies with RF specifications when the device used at 20 cm from your body.

## National Restrictions

Attention: This device may only be used indoors in all EU member states, EFTA countries and Northern Ireland.

	AT	BE	BG	CH	CY	CZ	DE	DK
	EE	EL	ES	FI	FR	HR	HU	IE
	IS	IT	LI	LT	LU	LV	MT	NL
	NO	PL	PT	RO	SE	SI	SK	UK(NI)

Frequency band: 5150 - 5250 MHz:

Indoor use: Inside buildings only. Installations and use inside road vehicles and train carriages are not permitted. Limited outdoor use: If used outdoors, equipment shall not be attached to a fixed installation or to the external body of road vehicles, a fixed infrastructure or a fixed outdoor antenna. Use by unmanned aircraft systems (UAS) is limited to within the 5170 - 5250 MHz band.

## UKCA Mark



For PG2400P

## UK Declaration of Conformity

TP-Link hereby declares that the device is in compliance with the essential requirements and other relevant provisions of the Electromagnetic Compatibility Regulations 2016 and Electrical Equipment (Safety) Regulations 2016.

The original UK declaration of conformity may be found at <https://www.tp-link.com/support/ukca/>

## For PGW2440

### UK Declaration of Conformity

TP-Link hereby declares that the device is in compliance with the essential requirements and other relevant provisions of the Radio Equipment Regulations 2017.

The original UK Declaration of Conformity may be found at <https://www.tp-link.com/support/ukca/>

### National Restrictions

Attention: This device may only be used indoors in Great Britain.

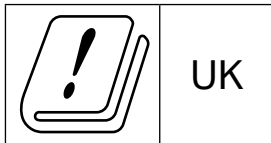

### Canadian Compliance Statement

This device contains licence-exempt transmitter(s)/receiver(s) that comply with Innovation, Science and Economic Development Canada's licence-exempt RSS(s). Operation is subject to the following two conditions:

- (1) This device may not cause interference.
- (2) This device must accept any interference, including interference that may cause undesired operation of the device.

L'émetteur/récepteur exempt de licence contenu dans le présent appareil est conforme aux CNR d'Innovation, Sciences et Développement économique Canada applicables aux appareils radio exempts de licence. L'exploitation est autorisée aux deux conditions suivantes :

- 1) L'appareil ne doit pas produire de brouillage;
- 2) L'appareil doit accepter tout brouillage radioélectrique subi, même si le brouillage est susceptible d'en compromettre le fonctionnement.

### Caution:

The device for operation in the band 5150–5250 MHz is only for indoor use to reduce the potential for harmful interference to co-channel mobile satellite systems;

## **Avvertissement:**

Le dispositif fonctionnant dans la bande 5150-5250 MHz est réservé uniquement pour une utilisation à l'intérieur afin de réduire les risques de brouillage préjudiciable aux systèmes de satellites mobiles utilisant les mêmes canaux

## **Radiation Exposure Statement**

This equipment complies with IC radiation exposure limits set forth for an uncontrolled environment. This equipment should be installed and operated with minimum distance 20cm between the radiator & your body.

## **Déclaration d'exposition aux radiations**

Cet équipement est conforme aux limites d'exposition aux rayonnements IC établies pour un environnement non contrôlé. Cet équipement doit être installé et utilisé avec un minimum de 20 cm de distance entre la source de rayonnement et votre corps.

## **Industry Canada Statement**

CAN ICES-3 (B)/NMB-3(B)

CAN ICES-6/NMB-6



## **Korea Warning Statements**

당해 무선설비는 운용중 전파혼신 가능성이 있음.

## **NCC Notice**

注意!

取得審驗證明之低功率射頻器材，非經核准，公司、商號或使用者均不得擅自變更頻率、加大功率或變更原設計之特性及功能。

低功率射頻器材之使用不得影響飛航安全及干擾合法通信；經發現有干擾現象時，應立即停用，並改善至無干擾時方得繼續使用。

前述合法通信，指依電信管理法規定作業之無線電通信。

低功率射頻器材須忍受合法通信或工業、科學及醫療用電波輻射性電機設備之干擾。

應避免影響附近雷達系統之操作。

## **BSMI Notice**

安全諮詢及注意事項

- 請使用原裝電源供應器或只能按照本產品注明的電源類型使用本產品。

- 清潔本產品之前請先拔掉電源線。請勿使用液體、噴霧清潔劑或濕布進行清潔。
- 注意防潮，請勿將水或其他液體潑灑到本產品上。
- 插槽與開口供通風使用，以確保本產品的操作可靠並防止過熱，請勿堵塞或覆蓋開口。
- 請勿將本產品置放於靠近熱源的地方。除非有正常的通風，否則不可放在密閉位置中。
- 不要私自拆開機殼或自行維修，如產品有故障請與原廠或代理商聯繫。

設備名稱： Equipment name						
G.hn2400 Powerline AX1800 Wi-Fi 6 Extender/G.hn2400 Passthrough Powerline Adapter				型號（型式）： Type designation (Type) PGW2440/PG2400P		
單元 U nit	限用物質及其化學符號 Restricted substances and its chemical symbols					
	鉛 Lead (Pb)	汞 Mercury (Hg)	鎘 Cadmium (Cd)	六價鉻 Hexavalent chromium (Cr <sup>+6</sup> )	多溴聯苯 Polybrominated biphenyls (PBB)	多溴二苯醚 Polybrominated diphenyl ethers (PBDE)
PCB	○	○	○	○	○	○
外殼	○	○	○	○	○	○
電源供應板	—	○	○	○	○	○
其他及其配件	—	○	○	○	○	○
備考 1. “超出 0.1 wt %” 及 “超出 0.01 wt %” 係指限用物質之百分比含量超出百分比含量基準值 Note 1: “Exceeding 0.1 wt %” and “exceeding 0.01 wt %” indicate that the percentage content of the restricted substance exceeds the reference percentage value of presence condition.						
備考 2. “○” 係指該項限用物質之百分比含量未超出百分比含量基準值。 Note 2: “○” indicates that the percentage content of the restricted substance does not exceed the percentage of reference value of presence.						
備考 3. “—” 係指該項限用物質為排除項目。 Note 3: The “—” indicates that the restricted substance corresponds to the exemption.						



Продукт сертифіковано згідно с правилами системи УкрСЕПРО на відповідність вимогам нормативних документів та вимогам, що передбачені чинними законодавчими актами України.



## Safety Information





- Keep the device away from water, fire, humidity or hot environments.

- Do not attempt to disassemble, repair, or modify the device. If you need service, please contact us.
- Do not use the device where wireless devices are not allowed.
- The socket-outlet shall be installed near the equipment and shall be easily accessible.

-  For passthrough devices, plug the power strips into the integrated electrical sockets of the devices, but devices of the same or another type not be stacked in normal use.
- Plug the powerline devices directly into the wall outlets but not the power strips.
- Nicht hintereinander stecken.
- Operating Temperature: 0°C ~ 40°C (32°F ~ 104°F)
- This product uses radios and other components that emit electromagnetic fields. Electromagnetic fields and magnets may interfere with pacemakers and other implanted medical devices. Always keep the product and its power adapter more than 15 cm (6 inches) away from any pacemakers or other implanted medical devices. If you suspect your product is interfering with your pacemaker or any other implanted medical device, turn off your product and consult your physician for information specific to your medical device.

Please read and follow the above safety information when operating the device. We cannot guarantee that no accidents or damage will occur due to improper use of the device. Please use this product with care and operate at your own risk.

### Explanation of the symbols on the product label

Symbol	Explanation
	AC voltage
	Indoor use only
	Caution
	Operator's manual
	<p>RECYCLING</p> <p>This product bears the selective sorting symbol for Waste electrical and electronic equipment (WEEE). This means that this product must be handled pursuant to European directive 2012/19/EU in order to be recycled or dismantled to minimize its impact on the environment.</p> <p>User has the choice to give his product to a competent recycling organization or to the retailer when he buys a new electrical or electronic equipment.</p>