

1 Overview

PSM150-AC

The PSM150-AC is an AC-input and DC-output power supply module. It can convert the input voltage to 12 V with the maximum output power of 150 W.

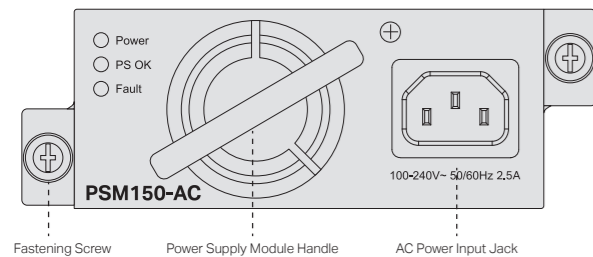

PSM150-DC

The PSM150-DC is a DC-input and DC-output power supply module. It can convert the input voltage to 12 V with the maximum output power of 150 W.

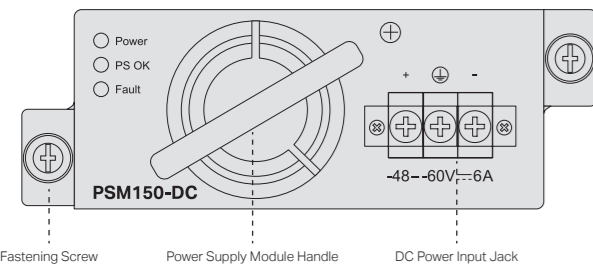

2 LED and Feature Explanation

LED Status	Description
Power On PS OK Off Fault Off	Power supply module is powered on and running well, but not supplying power to the device.
Power On PS OK On Fault Off	Power supply module is powered on and running well, and supplying power to the device.
Power On Fault On PS OK Off	The circuit has faults, such as output over-voltage ¹ , output under-voltage, output over-current ¹ , output short circuit, hot-swap control failure ² or fan fault ³ .
Power Off PS OK Off Fault Off	Power off or power supply fault.

Note:

1. The failure of output over-voltage or over-current may cause the power LED to flash.
2. Hot-swap control function will be checked when the module is powered on but has not been inserted into the device. If the Fault LED is on under this condition, please do not insert the module into the device, otherwise the power supply module or the powered devices may be damaged.
3. There is still power supply when a fan fault occurs, do not touch the module.

Feature	Description
Protection Function	Includes protection of output over-voltage, output under-voltage, output short circuit and output over-current.
Redundant Backup	Supports dual power modules combining in parallel to implement 1+1 redundancy for uninterruptible power supply.
Hot Swappable	In the case of 1+1 redundant power supply system, the power supply module can be plugged out or plugged in without shutting down the OLT.

When the power module reverts to the protected state, its recovery features are as follows.

Protection Function	Protective Action	Recovery Characteristics
Output over-voltage & under-voltage protection	Power supply module locked and cut-off supply	The power supply module can not recover automatically.
Output short circuit protection	Power supply module locked and cut-off supply	Power supply module reverts into the auto-retry mode. It can recover automatically when the fault is cleared.
Output over-current protection	Power supply module locked and cut-off supply	Power supply module reverts into the auto-retry mode. It can recover automatically when the fault is cleared.

Note: When the power supply module is locked or auto-retry continually, you can try the following steps to restore the device.

1. Disconnect the power cord from the external power supply system.
2. Disconnect the power cord from the power supply module.
3. Remove the power supply module from the device.
4. Insert the power supply module again.
5. Connect the power cord to the power supply module again.
6. Connect the other end of the power cord to the external supply system.

3 Specification

	PSM150-AC	PSM150-DC
Power Input	100 V~240 V~ 50/60 Hz 2.5A	-48 ~ -60 V --- 6 A
Output Voltage	12 VDC	12 VDC
Output Current	12.5 A (Maximum)	12.5 A (Maximum)
Output Power	150 W (Maximum)	150 W (Maximum)
Mains Transient Voltage	/	2500 V _{peak} (Maximum) ¹
Temperature	Operation : 0°C to 50°C (32 to 122°F) Storage: -40°C to 70°C (-40 to 158°F)	
Humidity	Operation : 10% to 90% RH Non-condensing Storage: 5% to 90% RH Non-condensing	
Altitude	Sea level to 4000 m	

Note:

1. The product can be powered by a DC power source such as accumulator cell and a power supply server. The DC power supply should comply with EN 62368-1 2014 clause 5.4.2.3.2.3, and the transient voltage shall be no more than 2500 V_{peak}.

4 Installation

For simplicity, we will take PSM150-AC for example.

Safety Information

To avoid damage to the power supply module and the equipment and bodily injury, the product can only be used by instructed persons.

Please observe the following notes:

- When you install and remove the power supply module, please wear an ESD-preventive wrist strap, and make sure that it has good skin contact and is well grounded.
- Before installing the power supply module, make sure that the voltage of external power supply system is the same with the voltage marked in the power supply module, and the output voltage of the power supply module is the same with the required voltage of the powered devices in order to prevent damaging the power supply module or the powered devices.
- Do not touch any exposed wires or terminals to avoid bodily injury.
- Do not place the power module in a humid place or let the liquid into the power supply module.
- If there is a failure inside the module, please contact service personnel, instead of opening the housing of the module.
- For PSM150-DC, the rating of the external overcurrent protective device shall not exceed 16 A.
- For PSM150-DC, an all-pole mains switch in accordance with EN 62368-1 2014 Annex L shall be incorporated in the electrical installation of the building. And the disconnect device shall have a contact separation of at least 1.5 mm.
- The equipment must not be used in locations where children are likely to be present.

Tools for Installation

- Straight screwdriver
- Philips screwdriver
- ESD-preventive wrist strap

Install the Power Supply Module

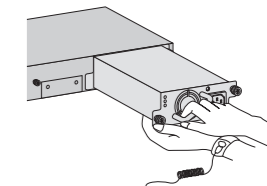

1. Wear an ESD-preventive wrist strap, and make sure that it has good skin contact and is well grounded.
2. Grip the handle of the module with one hand, and hold the bottom of the module using your other hand. Gently push the module in along the slot guide rail.
3. Tighten the captive screws with a Phillips screwdriver to fix the power supply module in place.

PSM150-AC:

Connect the Power Cord and Connect to the Ground

After the power supply module is installed on the device, please plug the female connector of the provided power cord into the power socket of the device, and the male connector into a power outlet. Meanwhile, it will connect to the ground via the power supply.

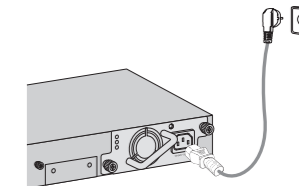



PSM150-DC: Connect the Power Cord and Connect to the Ground

1. Connect the power cord

It is recommended to use an 18-14 AWG power cord to connect the power supply equipment and PSM150-DC, and make sure that the connection is reliable. When connecting, make sure that the positive and negative poles of the power supply equipment correspond to the positive and negative poles of the PSM150-DC.

2. Connect to the ground

In different environments, the device may be grounded differently. The following will instruct you to connect the device to the ground in two ways. Note that the protective earthing terminal must be connected to the installation protective earthing conductor.

• Use the grounding bar

If the device is installed in the Equipment Room, where a grounding bar is available, it is recommended to connect the device to the grounding bar with an 18-14 AWG ground cable as shown in the following figure.

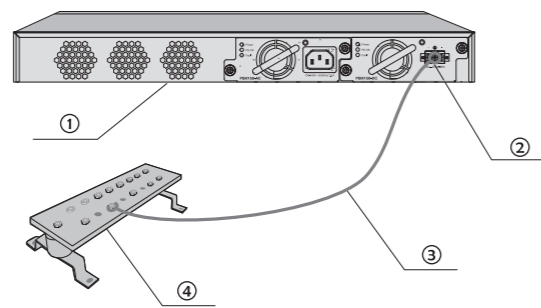

① Device (Rear Panel) ② Grounding Terminal
③ Ground Cable (18-14 AWG) ④ Grounding Bar

• Equipotential bonding

Equipotential bonding is the practice of intentionally electrically connecting all earthed systems to the same grounding grid or connecting the grounding grids of all the earthed systems together through the ground or overground metal so as to create an earthed equipotential zone. When lightning occurs, the high voltage produced by lightning current in all systems will meanwhile exist in their ground cables, and thus all ground cables have the same electrical potential and basically eliminate the electric strikes between the systems. The figure below illustrates how to practice equipotential bonding in a network.

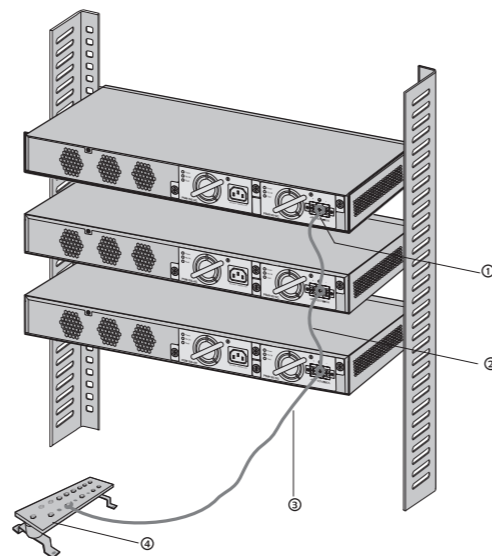

① Grounding Terminal ② Equipotential Bonding Cable
③ Ground Cable (18-14 AWG) ④ Grounding Bar

Remove the Power Supply Module

1. Wear an ESD-preventive wrist strap, and make sure that it has good skin contact and is well grounded.
2. Remove the power cord from the external power supply system and the power module.
3. Use a Phillips screwdriver to loosen the captive screws at both sides of the power supply module until all spring pressure is released.
4. Pull the handle with one hand along the guide rails, and hold the bottom of the module using your other hand, until it completely comes out of the chassis.

Note:

When installing or removing a power supply module, pay attention to the following points:

- Make sure that the power supply module is set correctly in the operation of installation.
- Do not use too much force in the installation. If resistance is encountered or positions of the power supply module appear larger during installation, you must first remove the module and then reinstall the module.
- If screws cannot be tightened, it may be due to the power supply module is not installed properly. Please check carefully.
- In order to better protect the power supply module during removal, it is recommended that you package it in an antistatic bag.

Safety Information

- Keep the device away from water, fire, humidity or hot environments.
- Do not attempt to disassemble, repair, or modify the device. If you need service, please contact us.
- Avoid using this product during an electrical storm. There may be a remote risk of electric shock from lightning.

EU Declaration of Conformity

TP-Link hereby declares that the device is in compliance with the essential requirements and other relevant provisions of directives 2014/30/EU, 2014/35/EU, 2009/125/EC, 2011/65/EU and (EU)2015/863. The original EU declaration of conformity may be found at <https://www.tp-link.com/en/support/ce/>

UK Declaration of Conformity

TP-Link hereby declares that the device is in compliance with the essential requirements and other relevant provisions of the Electromagnetic Compatibility Regulations 2016 and Electrical Equipment (Safety) Regulations 2016. The original UK Declaration of Conformity may be found at <https://www.tp-link.com/support/ukca>



Installation Guide

Power Supply Module

To ask questions, find answers, and communicate with TP-Link users or engineers, please visit <https://community.tp-link.com> to join TP-Link Community.

For technical support, the user guide and other information, please visit <https://www.tp-link.com/support>, or simply scan the QR code.

If you have any suggestions or needs on the product guides, welcome to email techwriter@tp-link.com.cn.



FCC compliance information statement

Product Name: Power Supply Module
Model Number: PSM150-AC/PSM150-DC

Responsible party:
TP-Link USA Corporation, d/b/a TP-Link North America, Inc.
Address: 10 Mauchly, Irvine, CA 92618
Website: <https://www.tp-link.com/us/>
Tel: +1 626 333 0234
Fax: +1 909 527 6803
E-mail: sales.usa@tp-link.com

This equipment has been tested and found to comply with the limits for a Class A digital device, pursuant to part 15 of the FCC Rules. These limits are designed to provide reasonable protection against harmful interference when the equipment is operated in a commercial environment. This equipment generates, uses, and can radiate radio frequency energy and, if not installed and used in accordance with the instruction manual, may cause harmful interference to radio communications. Operation of this equipment in a residential area is likely to cause harmful interference in which case the user will be required to correct the interference at his own expense.

We, TP-Link USA Corporation, has determined that the equipment shown as above has been shown to comply with the applicable technical standards, FCC part 15. There is no unauthorized change is made in the equipment and the equipment is properly maintained and operated.

Issue Date: 2021/07/01







This device complies with part 15 of the FCC Rules. Operation is subject to the following two conditions:

- 1) This device may not cause harmful interference.
 - 2) This device must accept any interference received, including interference that may cause undesired operation.
- Any changes or modifications not expressly approved by the party responsible for compliance could void the user's authority to operate the equipment.

CE Mark Warning

This is a class A product. In a domestic environment, this product may cause radio interference, in which case the user may be required to take adequate measures.

Explanation of the symbols on the product label

	DC voltage
	AC voltage
	<p>RECYCLING</p> <p>This product bears the selective sorting symbol for Waste electrical and electronic equipment (WEEE). This means that this product must be handled pursuant to European directive 2012/19/EU in order to be recycled or dismantled to minimize its impact on the environment.</p> <p>User has the choice to give his product to a competent recycling organization or to the retailer when he buys a new electrical or electronic equipment.</p>
	Indoor use only
	Caution
	Operator's manual

BSMI Notice

安全諮詢及注意事項

- 請使用原裝電源供應器或只能按照本產品注明的電源類型使用本產品。
- 清潔本產品之前請先拔掉電源線。請勿使用液體、噴霧清潔劑或濕布進行清潔。
- 注意防潮，請勿將水或其他液體潑灑到本產品上。
- 插槽與開口供通風使用，以確保本產品的操作可靠並防止過熱，請勿堵塞或覆蓋開口。
- 請勿將本產品置放於靠近熱源的地方。除非有正常的通風，否則不可放在密閉位置中。
- 請不要私自拆開機殼或自行維修，如產品有故障請與原廠或代理商聯繫。

此為甲類資訊技術設備，于居住環境中使用時，可能會造成射頻擾動，在此種情況下，使用者會被要求採取某些適當的對策。

限用物質含有情況標示聲明書

產品元件名稱	限用物質及其化學符號					
	鉛 Pb	鎘 Cd	汞 Hg	六價鉻 Cr ⁶⁺	多溴聯苯 PBB	多溴二苯醚 PBDE
PCB	○	○	○	○	○	○
外殼	○	○	○	○	○	○
備考： "○"系指該項限用物質之百分比含量未超出百分比含量基準值。						

Industry Canada Statement

CAN ICES-3 (A)/NMB-3(A)

この装置は、クラスA情報技術装置です。この装置を家庭環境で使用すると電波妨害を引き起こすことがあります。この場合には使用者が適切な対策を講ずるよう要求されることがあります。

VCCI-A